

TOOTER FINDS STATIONS

RADIO
REG. U.S. PAT. OFF.
WORLD

NOVEMBER

1937

**BURIED
WIRE
KILLS
NOISE**

SEE PAGE .10

25¢
PER COPY



Latitude 20.5 S. . . Longitude 131 W.

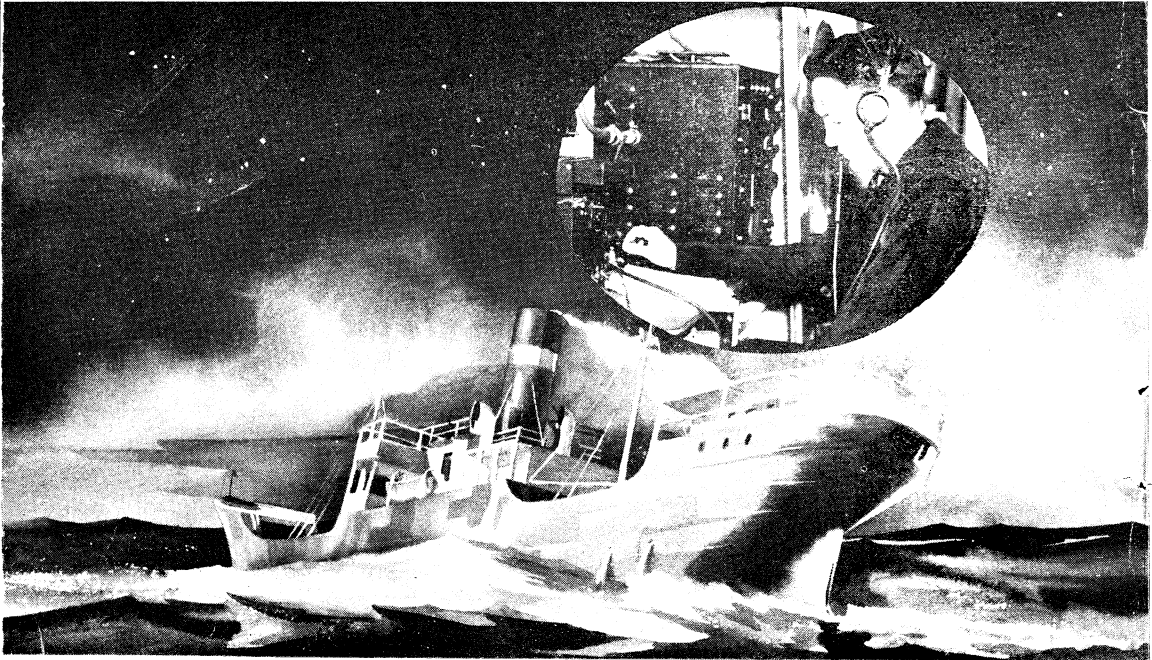

But the Mainland's at His Finger Tips

TYPE TJ-U DYKANOL TRANSMITTING CAPACITORS

This outstanding series of C-D capacitors has been widely adapted for both industrial and broadcast high voltage applications. New universal mounting clamp permits either vertical or horizontal installation of these capacitors. Other types described in detail in catalog 150.

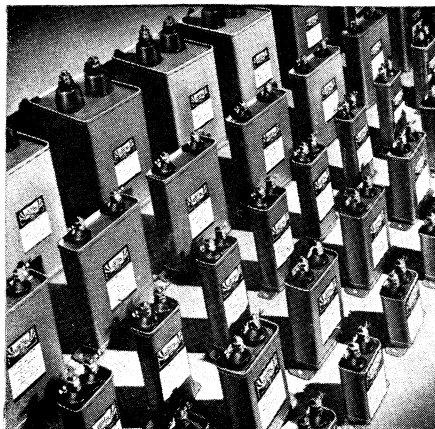

THE steamer a thousand miles out today is within speaking distance of home, of weather bureau and Coast Guard. The air liner . . . alone in a strange world of clouds and darkness . . . is guided by a voice from the ground. Sound transmission has made the earth "a small world after all."

Playing a vital role in man's conquest over distance and time is CORNELL-DUBILIER. The success of transmitting equipment depends upon the quality of the capacitors used. Aware of the importance of capacitors, radio engineers everywhere standardize on C-D. They know that in capacitors, CORNELL-DUBILIER is another name for **DEPENDABILITY**.

They know, because for more than twenty-seven years, C-D capacitors have stood the test of time under the most trying weather and circuit conditions. Such unflinching service has won the CORNELL-DUBILIER international acceptance. A fitting tribute to C-D capacitors. And a salute to the training, the craftsmanship and persistence of CORNELL-DUBILIER engineers.

Complete catalog material available on request.

Cornell-Dubilier Electric Corporation

1024 Hamilton Boulevard

So. Plainfield, N. J.



CORNELL-DUBILIER

ELECTRIC CORPORATION

South Plainfield, New Jersey



I WILL TRAIN YOU AT HOME IN SPARE TIME FOR A GOOD RADIO JOB!

J. E. SMITH, President
National Radio Institute
Established 1914

**HERE'S
PROOF**



**Works for
State of
Illinois**

"If I had not taken your Course I would still be digging ditches. I am glad for the working for their 1,000 watt transmitter. If anyone wants to write me about your Course, I shall be glad to answer."
R. S. LEWIS, Police Radio Station WQPM, Macomb, Ill.

**Picked up
\$1,800 While
Learning**

"I picked up \$1,800 while studying and I call that easy money — the time I gave my Radio work did not interfere with my other business."
OTIS DENTON, 14105 Lorain Ave., Cleveland, Ohio.



**Lesson on Radio
Servicing TIPS FREE**

I'll prove that my Training is just what you need to master Radio. My sample lesson text, "Radio Receiver Troubles — Their Cause and Remedy," covers a long list of Radio receiver troubles in A.C., D.C., battery, universal, auto, T. R. F., super-heterodyne, all-wave, and other types of sets. And a cross reference system gives you the probable cause and a quick way to locate and remedy these set troubles. A special section is devoted to receiver check-up, alignment, balancing, neutralizing and testing. Get this lesson Free. No obligation.

**The Tested WAY
to BETTER PAY**

**FREE BOOK TELLS HOW
MAIL COUPON**

Do you want to make more money? Radio offers many opportunities for well-paying spare time and full time jobs. You don't have to give up your present job, leave home or spend a lot of money to become a Radio Expert.

**Many Radio Experts Make
\$30, \$50, \$75 a Week**

Radio broadcasting stations employ engineers, operators, station managers and pay up to \$5,000 a year. Spare time Radio set servicing pays many \$200 to \$500 a year—full time jobs with Radio jobbers, manufacturers and dealers as much as \$30, \$50, \$75 a week. Many Radio Experts operate full time or part time Radio sales and service businesses. Radio manufacturers and jobbers employ testers, inspectors, foremen, engineers, servicemen, paying up to \$8,000 a year. Radio operators on ships get good pay, see the world besides. Automobile, police, aviation, commercial Radio, loud speaker systems are newer fields offering good opportunities now and for the future. Television promises to open many good jobs soon. Men I trained have good jobs in these branches of Radio. Read their statements. Mail the coupon.

**There's a Real Future in Radio
for Well Trained Men**

Radio already gives good jobs to more than 300,000 people. In 1936, Radio enjoyed one of its most prosperous years. More than \$500,000,000 worth of sets, tubes and parts were sold—an increase of more than 60% over 1935. Over a million Auto Radios were sold, a big increase over 1935. 24,000,000 homes now have one or more Radio sets. More than 4,000,000 autos are Radio equipped. Every year millions of sets go out of date, are replaced with newer models. More millions need servicing, new tubes, repairs, etc. A few hundred \$30, \$50, \$75 a week jobs have grown to thousands in 20 years. And Radio is still a new industry—growing fast!

**Many Make \$5, \$10, \$15 a Week Extra
in Spare Time While Learning**

Almost every neighborhood needs a good spare time serviceman. The day you enroll I start sending Extra Money Job Sheets showing how to do Radio repair jobs. Throughout your training I send plans and ideas that made good spare time money for hundreds. I send Special Equipment to conduct experiments, build circuits, get practical experience. I GIVE YOU A COMPLETE, MODERN, PROFESSIONAL ALL WAVE, ALL PURPOSE RADIO SET SERVICING INSTRUMENT TO HELP SERVICE SETS QUICKER—SAVE TIME, MAKE MORE MONEY.



I Give You Practical Experience

My Course is not all book training. I send you special Radio equipment, show you how to conduct experiments, build circuits illustrating important principles used in modern Radio receivers, broadcast stations and loud speaker installations. I show you how to build testing apparatus for use in spare time work from this equipment. Read about this 50-50 method of training—how it makes learning at home interesting, practical. Mail coupon.

Money Back Agreement Protects You

I am sure I can train you successfully. I agree in writing to refund every penny you pay if you are not satisfied with my Lessons and Instruction Service when you finish. I'll send you a copy of this agreement with my Free Book.

Find Out What Radio Offers You

Act Today. Mail the coupon now for "Rich Rewards in Radio." It's free to any fellow over 16 years old. It points out Radio's spare time and full time opportunities and those coming in Television; tells about my training in Radio and Television; shows you letters from men I trained, telling what they are doing and earning. Find out what Radio offers YOU! MAIL THE COUPON in an envelope, or paste on a penny post card.

J. E. SMITH, President, Dept. 7MM4
National Radio Institute,
Washington, D. C.

**MAIL
COUPON
NOW!**



**This FREE BOOK has Helped Hundreds
of Men to Make More Money**

J. E. SMITH, President, Dept. 7MM4
National Radio Institute, Washington, D.C.

Dear Mr. Smith: Without obligation send me free the Sample Lesson and your 64-Page Book, "Rich Rewards in Radio," telling about spare time and full time Radio opportunities, and how I can train for them at home in spare time. (Please write plainly)

NAME..... AGE.....
ADDRESS.....
CITY..... STATE..... 14X1

RADIO WORLD, November, 1937. Published monthly. Vol. XXX. No. 8. Whole No. 710. Address, 145 West 45th Street, New York, N. Y. Subscription price, \$2.50 per annum (foreign, \$3.00). Single copy, 25c. Published by Hennessy Radio Publications Corporation. Entered as second class matter March, 1922, at the Post Office at New York, N. Y., under Act of March 3rd, 1879.

EMERSON ALL-WAVE SUPER

- 7 tube 3 band
- full size chassis
- 8" dynamic speaker
- acoustical baffle
- magic eye
- 16-50-170-550 meter
- tone control
- automatic volume control
- 7 RCA tubes
- 6 1/2" Gemloid dial
- straight a.c.
- factory cartons
- 100% guarantee

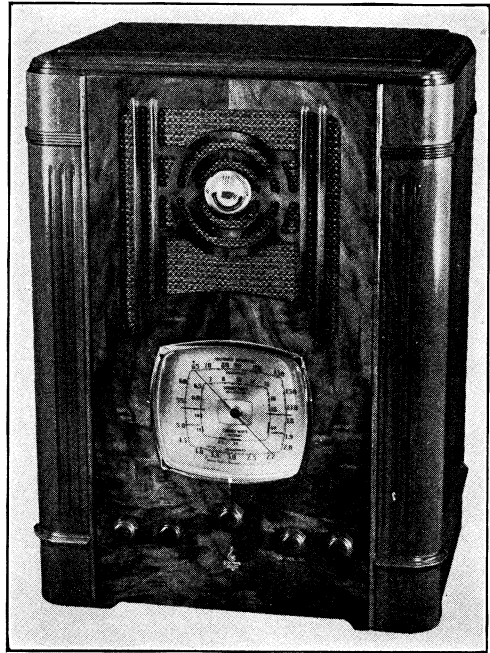

BEAUTIFUL HANDRUBBED CABINET MEASURES 22" HIGH, 17" WIDE, 12" DEEP USES 2-6K7, 1-6A8, 1-6Q7, 1-6F6 METAL TUBES AND 1-5Z3 GLASS. RECTIFIER, 1-6E5 MAGIC EYE.

COMPLETE
with
7 RCA TUBES
F.O.B. New York

28.50



SPECIAL

A few genuine RCA-Victor Auto Sets, Model 67M1, list \$55.00, still available at \$25.45. Specify car model and year.

SONORA RECORD-PLAYER

- Genuine Crystal Pickup
- Self-Starting Motor
- Speed Regulation
- Built-in Volume Control
- Attractive Mahogany Case
- Attaches to Any Radio
- Case 15" Wide, 13" Deep, 7" High. Complete with Cord F.O.B. New York

18.75

All Orders Require 20% Deposit

THOR RADIO CO.

65 CORTLANDT STREET, NEW YORK CITY



**"GET MY
FREE RADIO LESSON"**

**MAKE \$40-\$60 a WEEK
with this New Kind of Radio Training**

SETS YOU UP FOR BUSINESS!

Now there's a new kind of Radio training every man should know about if he wants to get in on the money end of the Radio industry. Men taking my training right now are actually earning \$10, \$15, \$20 a week and more in spare time—while they learn. Men who have graduated are holding down jobs paying \$60 a week and up.

MAKE MORE MONEY QUICK

My course is arranged so that you get practical lessons right at the start. Quickly, you are ready to begin servicing sets. Useful, simple job sheets show you every step to take. And you have the equipment to handle these jobs properly. Time and time again my students write in to tell me they are handling jobs other Radio men couldn't handle. That's because my easy to understand lessons and professional equipment make you a real Radio expert.

NO EXPERIENCE NEEDED

Old-timers and new-comers are taking this new kind of training and making real money in Radio. If you are a Radio man now, you know now is the time to get extra training and bigger pay. If you are just about to enter Radio, now is the time to start taking this thorough, easily-learned course. Everything is clear. Everything practical. You learn business methods, gain self-confidence, get the satisfaction that nothing but quick cash in the pocket can give you.

GET THE FACTS

Your future in Radio can be rich and happy if you get started on the right track, get the kind of instruction that puts you ahead of others from the start. My new book, entitled "MORE MONEY IN RADIO" tells about Radio's spare-time and full-time opportunities, tells you about my unusual new type of practical Radio training, shows you letters from men who have found success this way, shows how YOU can do the same. Send for this book today and get the facts. Act now! Fill in and mail this coupon at the right.

BIG PROFESSIONAL OUTFIT SENT

You learn at home, in your spare time, you train on real Radio parts, with real professional tools and implements. I send them to you as part of your course. This big professional outfit is practically an entire Radio shop in itself.

**MASTER SERVICE COURSE
FOR SERVICE MEN ONLY**

For you men already in the business, I have my famous "Master Service Course" consisting of 45 important and practical lessons. Describes the actual how-to-do-it. Practical, modern and easy to understand. Every service man needs this special course. Nothing like it in print. Represents years and years of experience at actual Radio Service work. The free book "More Money in Radio" tells about both courses. **TERMS AS LOW AS \$3 PER MONTH. IRON-CLAD MONEY BACK AGREEMENT.** Fully protects you.



A. H. LANOIE, Northbridge, Mass., writes: "Since enrolling I have cleared a net profit of more than \$150 in spare time alone . . . and I am not half through the course yet. Honestly, I cannot understand how you can give so much 'dope' for so little money."

EDWIN A. GAMMON, Auburn, Maine, writes: "Your course is so thoroughly good and practical that it is hard to pick out one part that is better than any other. Due to the knowledge I have gotten from it I have been deluged with work for the last month, achieving good results with radios which had been unsuccessfully tackled by other service men. You deserve all the credit, and I can tell you how much I appreciate your course."



WALTER DAVIS, Baltimore, Md., writes: "Thanks to the Sprayberry Practical Course (for which I would not take anything or any price). I am now making on an average of from \$10 to \$25 per week in spare time work, and if this keeps up I may go in for full time radio servicing and sales. Thank you again."

**NOW SEND FOR
FREE BOOKS!**

My free books have started hundreds of men on the road to success in Radio and happiness in life. They're crammed with facts you can't afford to miss—filled with TRUE STORIES of men that I put into Radio. Get these books and read them. If others can succeed in Radio, so can you—it's all in getting started right.



ALSO FREE
When I send you my free book "More Money in Radio," I'll also send you one of my famous "BUSINESS BUILDERS."

MAIL THIS COUPON TODAY

SPRAYBERRY ACADEMY OF RADIO,
F. L. SPRAYBERRY, President,
35-M University Place, N. W., Washington, D. C.

Please send me a free copy of "More Money in Radio," and also a free "BUSINESS BUILDER."

Name Age
Address
City State

Paste coupon on penny postcard, mail TODAY.
If interested in Service Course only, check here ()

Copy of "The Inductance Authority" FREE with order for any of these three instruments

DeLuxe Superior GENEMETER

100 Kc to 100 Mc Signal Generator

With Variable Audio

\$14.40

Complete with Four Tubes

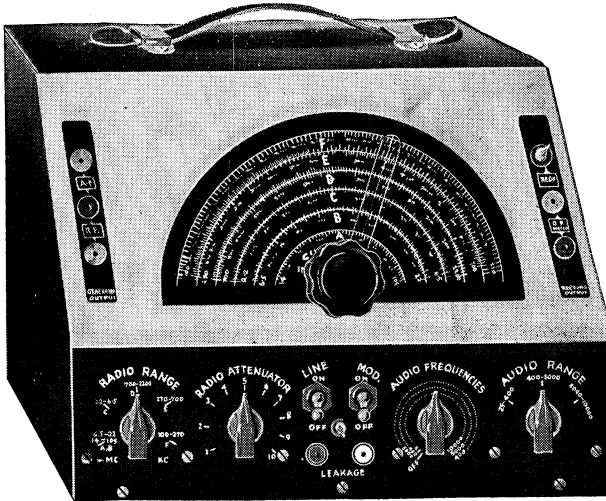

FEATURES:

1. Direct reading in frequencies, 100 kc — 22 mc, in five bands, all fundamentals, by front-panel switching. Ultra band by harmonics to 105 mc, also direct-reading.
2. Direct reading in frequencies, 25—10,000 cycles, in three bands, all fundamentals, by front-panel switching.
3. R.F. and A.F. outputs independently obtainable alone, or with A.F. (any frequency) modulating R.F.
4. Output meter for connection across primary of receivers' output transformer for peaking with modulation "on."
5. R.F. is subject to attenuation, and oscillation leakage is minimum.
6. Condenser and other leakages tested, to 100 megohms.
7. Main dial protracted on 7/2" diameter, used full size, with precision pointer (no parallax), and 4-to-1 vernier planetary drive.
8. All services on 90-130 volts a.c. or d.c.

Shipping weight, 10 lbs.

The Superior Tube Tester
 Price is only.. **\$10.40**
 Shipping weight, 10 lbs.



Our Tube Tester tests all 4, 5, 6, 7, 7L and octal base tubes, including diodes, triodes, pentodes and tetrodes, by the reliable and rapid emission-test method, using direct-reading "Good?—Bad" meter. Rugged, foolproof, it has minimum of adjustments.

The New **ALLMETER**
 for Rapid, Accurate **\$10.40**
 Measurements

The ALLMETER is a multi-purpose meter, 1,000 ohms per volt, d'Arsonval movement, for measuring a.c. and d.c. volts, a.c. and d.c. currents, capacity, decibels, resistance and inductance.

Shipping weight, 8 lbs.



The Allmeter, 22 instruments in one.

Volts and milliamperes, 15-15-750, a.c. and d.c.
 Capacity, .01-50 mfd., including electrolytics.
 Decibels, for total change of 42 db.
 Resistance, .03-500 and 500-500,000 ohms.
 Inductance, 5 to 1,000 henries.

ORDER DIRECT FROM

SUPERIOR INSTRUMENTS COMPANY
 DEPT. RW 11 — 136 LIBERTY ST., NEW YORK, N. Y.
 Send for Our Free Catalogue No. 129 in Colors

RADIO WORLD

SERVICING, MEASUREMENTS AND DEVELOPMENTS

Sixteenth Year

ROLAND BURKE HENNESSY
Editor

H. J. BERNARD
Publisher

HERBERT E. HAYDEN
Advertising Manager

Table of Contents for NOVEMBER, 1937

An Adventure in Noise Reduction 10	The "Faultless Oscilloscope" 32
<i>Unique Balancing System, Using Buried Wire</i>	<i>List of Parts for Diagram Pub- lished Last Month</i>
By George Bonadio	Columbia Broadcasting Sys- tem's Television 33
How to Use a Wobbulator . . 14	<i>First Power Tests Are Made at Camden, N. J.</i>
<i>Connection Methods, Reasons for Single and Double Traces</i>	Television Pickup Is Moved Outdoors 34
By Leland S. Hicks	<i>An Advance by National Broad- casting Company</i>
New Type Cabinet Developed 19	Foreign Television Ap- praised 39
<i>Original and Fetching Design</i>	<i>British Pictures Satisfactory, Not Many Sets Sold</i>
By Lewis Winner	By David Sarnoff
The Feedback Loop 21	Tooter Finds Stations Fast 42
<i>How to Determine Tickler Con- nections</i>	<i>A General Use for the Multi- vibrator</i>
By Russ Forrester	By Sidney S. Fleischman
Short - Wave Performance Improved 22	Buy a 'Scope 44
<i>New Tubes Permit Better Re- sults</i>	<i>And What to Do After You've Got It</i>
By H. J. Bernard	By Donald V. Osgood
Pentagrid Converter Per- formance 25	Pertinence of Impedances . . 48
<i>Amazing Phenomena Inside the Tube</i>	<i>Matching Applies to Many Circuits</i>
By George C. Connor	By Edward Duff
The Haynes Pocket Receiver 26	Importance of Chassis De- sign 51
<i>A One-Tube Super-Regenerator</i>	<i>Effect on Receiver Performance</i>
By George V. Dubuc	By Herbert E. Hayden
An Improved Volt - Ohm - Ammeter 28	
<i>Inductance and Capacity Also Measured</i>	
By A. J. Woolsey	

Vol. XXX, November, 1937. No. 8. Whole No. 710. RADIO WORLD, published monthly by Hennessy Radio Publications Corporation, 145 West 45th Street, New York, N. Y. Editorial and executive offices, 145 West 45th Street, New York, N. Y. Executives of RADIO WORLD: Roland Burke Hennessy, editor and business manager; H. J. Bernard, publisher; Herbert E. Hayden, advertising manager. Officers of corporation: Roland Burke Hennessy, president-treasurer; Roland Burke Hennessy, Jr., vice-president, H. J. Bernard, secretary. Entered as second-class matter March, 1922, at the Post Office at New York, N. Y., under Act of March 3rd, 1879.

SUBSCRIPTION RATE

Price 25 cents per copy. Subscription \$2.50 per year (12 issues); \$1.25 per six months (6 issues); postpaid in the United States and Possessions; \$3.00 per year, \$1.50 per six months, postpaid in all other countries. Remittance for foreign subscription should be by International money-order (postal or express) or draft against or discountable at New York bank.

RADIO WORLD is distributed by the American News Company and its Branches

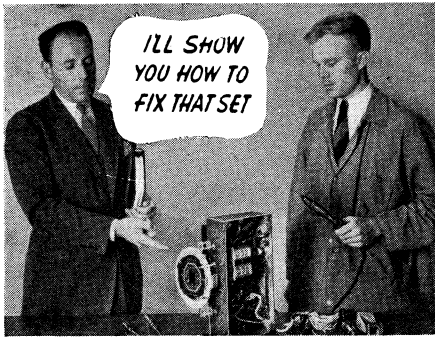

ALL SERVICE JOBS MADE EASY
 —if you use **"GHIRARDI"**

LET Alfred A. Ghirardi come into your shop and help you with your radio service work! It will be just like having constantly at your elbow one of the greatest radio servicing authorities in the world—when you get Ghirardi's 2 great servicing books and start using them in your shop. They're so practical and to the point—so clear and easy to understand—that they'll make every one of your jobs easier, quicker and more profitable to handle.

The whole science of radio servicing clearly explained.

In his MODERN RADIO SERVICING, Ghirardi gives you the most complete accumulated knowledge available on present-day servicing methods and practices—test instruments, trouble-shooting, repairing, etc. It tells you exactly **WHAT TO DO** and **HOW TO DO IT**—all in the plain simple language Ghirardi is noted for. It's a priceless gold-mine of shortcuts and tricks of the trade!

Get the handy DATA BOOK, too!

The loose-leaf RADIO FIELD SERVICE DATA BOOK you'll want to keep with you and use on every service job—both inside and out of the shop. It's full of just the kind of data you're always needing in a hurry—ready for instant use. Always up to date, because a regular Supplement Sheet Service keeps it so. Service men say it's the greatest time-saver they ever had. **Time means money**, so save your money by ordering today these 2 "extra hands" for your shop. **Mail the coupon right now!** You don't risk a single penny!

Here's What He'll Do for YOU!

TEST INSTRUMENTS

He'll show you all about the construction and operation of every type of servicing instrument, with diagrams, construction data, etc. He'll explain clearly all the latest commercial models and even show you how to build your own test instruments!

TROUBLE-SHOOTING

He'll give you the latest shortcuts in testing and trouble-shooting, for "obscure" as well as "common" problems. He'll explain the servicing of AVC and QAVC Circuits, etc.

REPAIR METHODS

He'll show you just how to use the most up-to-date methods in repairing all kinds of sets and individual components quickly, how to align superhets, how to get rid of noise, electrical interference, etc., etc.

SPECIALIZED SERVICING

He'll throw in a whole course on Auto-Radio installation and servicing from A to Z. He'll explain all about servicing All-Wave sets, High-Fidelity sets, etc.

CASE HISTORIES, etc.

He'll give you the "Case Histories" of over 1500 receivers to speed up your service work—and keep more coming to you regularly in his Supplement Sheet Service. He'll give you the I. F.'s of over 6,000 superhets. He'll give you tube data, Auto-Radio Installation and Servicing data for all cars, and over 25 other invaluable tables and charts for quick reference.

SENT POSTPAID ANYWHERE!

MODERN RADIO "Servicing" RADIO FIELD SERVICE DATA BOOK

"1800 PAGES" \$ 6
 813 ILLUS.
 Both Books for **6**

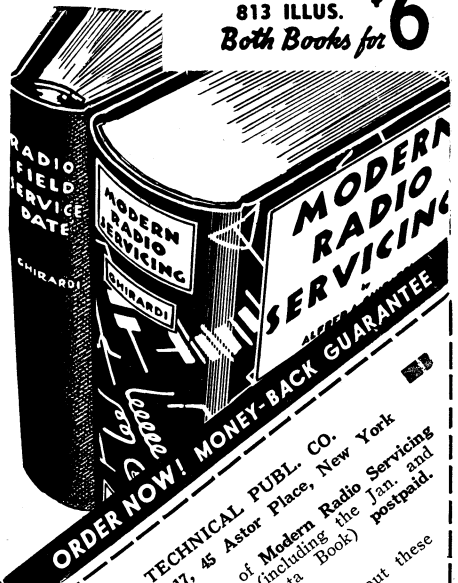

ORDER NOW! MONEY-BACK GUARANTEE
 TO: RADIO & TECHNICAL PUBL. CO.
 Dept. RW-117, 45 Astor Place, New York

Here is \$6 for my copies of Modern Radio Servicing and Radio Field Service Data (including the Jan. and June '37 Supplements to the Data Book) (\$6.50 foreign.)
 Please send me free descriptive literature about these 2 servicing books.

Name..... Address.....
 R W-117

AN ADVENTURE IN NOISE REDUCTION

Amateur Reports Success in His Unique Balancing System

By George Bonadio (W80MM)

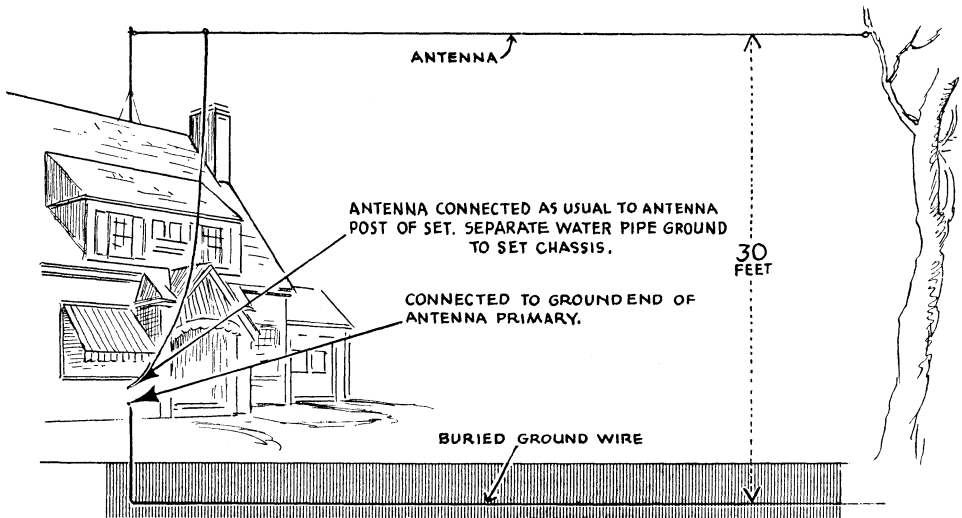

A most favorable installation of the noise-reducing system has the antenna elevated 30 feet at least, a buried ground wire of the same length as the aerial (say, 100 feet), a separate cold water pipe ground inside the house, receiver chassis grounded to the cold water pipe, and the ground end of the antenna primary to the buried wire's lead-in.

DESPITE definite demonstrations to the contrary, I received most of the blame for the neighborhood radio interference, because I operate amateur transmitter, W80MM. Why not? I hung out all sorts of directional antennas, reflectors, directors and phasing sections and shifted their positions at all odd times of the day and night. Worse than that, I went around in the meantime with portable gear.

When finally asked about a good static eliminating antenna for broadcast, I was forced to disappoint my friends by saying that I had not found any.

The shielded lead-in, I maintained, was all right for a narrow tuning range and its harmonics but because of its physical size was im-

practical for an efficient installation. The signal strength was usually greatly reduced.

The doublet was satisfactory for short waves but would be impractical for broadcast band pickup because of its size.

THE CHIEF REASON

The transformer on the line system is acceptable for short waves but loses its efficiency on the longer wavelengths unless the feeder picks up, which is just the reverse of the original intention.

Chiefly the reason for the poor results is plenty of interference where the main pickup is. The efficiency on the broadcast band is usually poor, thus relatively increasing the tube noises, or if the efficiency is good the feeder is

picking up a signal and therefore spoiling the noise elimination that the system is intended to introduce.

I realized that the ideal discriminating antenna, allowing a signal to pass but stopping all noise, would also cut out any modulation and would be completely impractical.

THE NEXT STEP

The next best should be a system that cancels out noises but allows signals to pass unmolested! Could it be done? Engineers had failed at this problem since the birth of wireless communication. What were their weak points? Why had they failed? Were they too busy with other things? To the last question I said no, because there is a steady stream of antennas being placed on the market. How about looking at the situation from a new angle?

A distant signal will induce a fair signal in an elevated antenna but a signal traveling through the soil won't get here at all from that station. The neighbor's electric razor will also put a signal into that same elevated antenna and one into the ground that will be almost as strong as the air path signal. The razor's two signals should be in phase when they get here and so if I could pick up a signal from the soil, directly under my antenna, I may be able to bring the signal into the set to cancel the antenna signal, similar to the cancellation effect of twisted feeders.

The house receiver would be an almost ideal set to try this on, as we never used a ground before, and the set has a tuning eye, so variation in signal strength of stations, and noise backgrounds, show in a definite manner.

First, a good piece of copper wire was run out to the newly laid copper water main and properly connected. Its application to the receiver actually reduced the noise level a little but not enough to justify exaltation. The connection was kept handy.

ELECTRICAL OPPOSITION

The antenna at this time was very well insulated and about 95% flat-top, 12 to 15 feet above the ground, as experience had taught me that was a passable height for a fair signal-to-noise ratio. I found some spare No. 14 solid enameled copper wire and ran a leadin from a point on the ground just below the house end of the flat-top into the receiver ground, taking care to use exactly as much wire for this leadin as for the antenna leadin—that is so the ground wire would be electrically opposite the antenna at any vertical point. I buried this wire about a quarter of an inch down in the sod and followed directly under the flat-top until I ran out of wire. This left about 25% of the antenna with no ground counterpart. The termination happened to be at a 90° turn in the flat-top.

Tests showed that the presence of the wire made no difference in noise level or signal strength if not connected to the receiver.

A good waterpipe ground varied some signals up a little, others down a little, while slightly

reducing the noise level. The outdoor mud-wire ground reduced all the signals somewhat, 5 db at the most, but greatly reduced the noise level so that the stations formerly in the hash

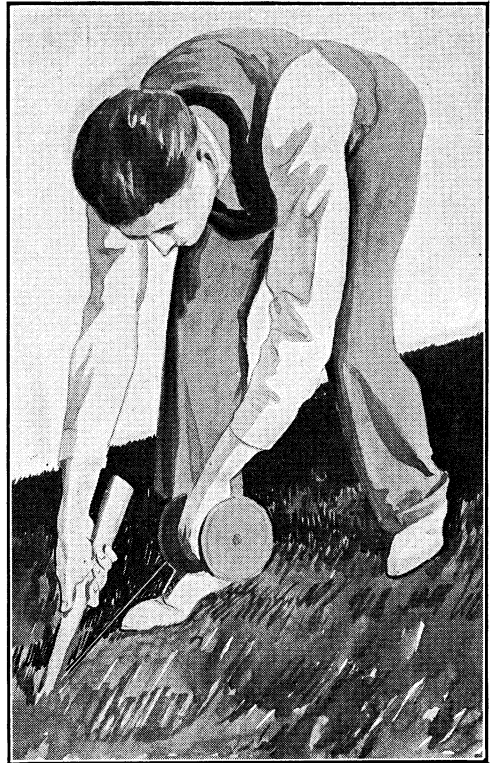

A buried ground wire is the basis of a new noise-reducing system. To lay the wire the author had wire spool in one hand and guided the wire in grooved plywood to force the wire into the ground. The method supplanted axe for handplow (above).

were practically in the clear, although their signal strength was slightly cut.

This I looked upon as an encouraging improvement, but not a solution in any sense.

REACTIVE EFFECT

Later, when the odd 25% of the antenna was shifted around and lengthened so that it favored European 25 meter signals, I added some more ground mudwire, No. 22, by just laying it on the ground in the bushes over which it passed. Tests showed that it still worked and that the longer the wavelength, the greater the reduction in noise-to-signal ratio so that, with no ground connection the long-wave code was seldom readable; with a watermain ground, was somewhat better; and with the mudwire seldom had a background level.

I told of my success to a neighbor and asked if I might experiment further with his layout.

(Continued on following page)

The Analytic Mind at 19

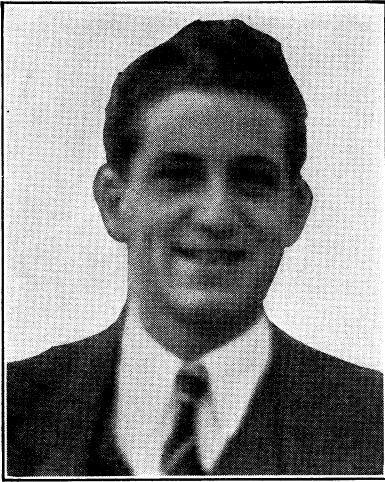

GEORGE A. BONADIO

The author, George A. Bonadio, is nineteen and has been a "ham" since July, 1935, when he was issued W80MM. His ambition is to spend all of his time experimenting with radio, television included. His mind is not normally divided between analysis and memory, but is so concentrated on analysis that his memory, he admits, may be poor at times. He readily admits that spelling and simple arithmetic are not his strong points because they are almost purely memory efforts. While he was in a camp as a scout, he acquired the nickname, Old Scientific, because he always had an explanation for anything that anybody was wondering about. When asked what he intends to do for a career, he replied that he expects to become a figure in retail trade. To the question, "Would that be connected with radio in any way?" he answers, "Probably not."

(Continued from preceding page)

Because his antenna was about twice as high as mine and ran over a corner of his house, a corner of his garage and over his garden, I told him not to expect as gratifying results. No. 22 enameled was used because that is what I had. This time I used an axe as a hand plow to gouge a quarter-inch ditch as near as possible to a line directly underneath his antenna.

A GREAT IMPROVEMENT

To lay the wire I had the spool in one hand and ran the wire to a groove in the edge of a small piece of plywood with which I was able to force the wire into the groove, at the distressing rate of about a mile an hour. This was a great improvement over the butcher-knife and finger-pushing system. Its water-

main ground was a poor one and therefore made no significant difference in signal or noise.

There was a great surprise for us as I applied the mudwire. Yes, the noise level did take a remarkable drop; but that wasn't the surprise. *The signal we were listening to came up so much in spite of the a.v.c. that the speaker blasted.* From a usual 8 to 10 clear stations in the noon hour, the total jumped to 19 at the time I was there.

We played around for a while, tuning in noises we thought were stations, then touching on the mudwire lead-in to find there either a clear channel or a signal of fair to good readability. I concluded that the flattop should be 18 or more feet above the soil for good results and that the size and path of the mudwire wasn't critical at all. Apparently bare or cloth covered wire should work better, as rain seemed to help slightly, possibly increasing the capacity of the mudwire to soil. The addition of the watermain ground in each of the above installations was of no apparent aid.

ONE MAN'S HOLIDAY

I installed the mudwire in one complainant's yard while he was on his vacation and checked upon his antenna and ground connections for him when he came home, "just to make sure there were no loose joints." Other than he can get 19 stations over his automatic noise suppression in place of 10 and that he doesn't complain of noise any more, I don't know just how his layout works; but neither does he know what I've done to it.

In the daytime an electric razor can run without any filter within thirty feet of my antenna, while I am listening to any of the ten strongest stations; and I can't hear the noise of the razor at all if the receiver is in perfect time. I haven't heard a vacuum cleaner since I installed the system.

The ideal layout would be one in which the antenna was quite high, say 30 feet, the insulation pieces being the fewest needed and of best quality, the ground wire as large or larger size than the antenna and directly under it for the full length, and a separate water main ground lead in of husky wire. The antenna would be connected as usual, as would be the water main ground wire to the metal chassis. The ground end of the antenna coil in the receiver should be attached only to the mudwire lead-in and should be well insulated from the chassis ground.

RECOMMENDED TO SKEPTICS

The closer the source of the signal, the better the cancellation. In other words, a local station may be slightly stepped down in comparison to distant signal ratios. Wouldn't that be a pleasure?

Uses suggest themselves at once. Such a balance system would sell a set to the most skeptical person. It will put every radio amateur back on friendly terms with his neighbors.

Sounds impossible, doesn't it? Well, fifty years ago radio itself was impossible, too.

Want a thrill? Just apply the system to your own receiver.

Right or Wrong?

PROPOSITIONS

- 1 When a beat-frequency oscillator does not produce a sound, although the radio-frequency oscillators are working, it is due to the intended audio frequency being either zero or at least below the lowest audible pitch, or to being above the highest audible pitch.
- 2 Dissimilar metals in contact, when a-c is applied to them, give a d-c output, because rectification arises from the dislocation of the molecules under the stress of the a-c excitation.
- 3 When two tubes are enclosed in the same envelope, the rule is to have the filament or heater current rating the same as for a single tube.
- 4 A relatively small capacity condenser connected across the line has a very small effect on line power frequencies, and therefore does little or no good in ridding a receiver of hum, or of otherwise improving the performance.
- 5 A transmission line in imperfect when it picks up or radiates energy well, and therefore itself neither brings in or sends out the wave most powerfully.
- 6 Most midget receivers have three-gang tuning condensers, because it is known that the extra t-r-f stage gets ride of squeals or "birdies" and therefore the precaution is nearly always included.

ANSWERS

- 1 Right. Obviously if the sound is of too high or too low a frequency the answer applies. Also, if the r-f oscillators lock, so that there is no difference in frequency, which is because coupling between them is too tight, nothing is heard. The lowest frequency that appears is a criterion of the suitability of the coupling.
- 2 Wrong. All rectification is due to a device passing current in one direction only, known as unilaerial operation, but just why the contacted dissimilar metals, like copper and copper oxide, produce this effect is not fully known.
- 3 Wrong. The rule is that when the number of tubes in the envelope is doubled the current rating of the filament or heater is doubled, although the voltage rating of the filament or heater remains unchanged. Hence the filament or heater power is doubled. It is only to be expected there would be twice as much emission available for two tubes than for one. An exception exists in the cases of some pentagrid converter tubes.
- 4 Wrong. The premise is correct, because the small capacity has a high reactance to low frequencies, hence little effect as to line frequency, but the presence of the condenser is directed at the radio frequencies picked up by the line in its unwelcome activity as antenna, and against these the condenser is very effective, and often eliminates hum modulation.
- 5 Right. The purpose of the transmission line is to conduct power from a source to a destination without loss, and this is accomplished very well, and in some instances almost completely. Therefore the line of itself is neither a collector nor a radiator, and if it is either it is not a transmission line.
- 6 Wrong. Practically all midget receivers, including superheterodynes, have only two-gang condensers, and that is why they may bring in squeals, because of poor preselection, in urban localities particularly.

RADIO KNIFE'S FUNCTION

The radio knife is a scalpel used as an electrode carrying high frequency current. It is used for its self-sterilizing properties and to cut tissue without producing bleeding, because of its production of immediate coagulation.

The healing effect after operation is very rapid.

CREDIT POST FOR VICTOR MUCHER

Victor Mucher is the new vice-chairman of the Eastern Credit Committee of Radio Manufacturers Association, Inc., succeeding Ed Metzger. Mr. Mucher is business manager of the Clarostat organization.

He has been prominent in the radio business for more than fifteen years.

HOW TO USE A WOBBULATOR

Connection Methods, Reasons for Single and Double Trace and Prac- tical Advice

THE adjustment of the i-f and r-f section of a radio receiver is one of the most important, as well as the most complicated, tasks of the serviceman. This is especially true with modern receivers incorporating i-f circuits with variable selectivity, automatic frequency control and all-wave reception. Unless this portion of the receiver passes all the signal broadcast, the best detector system and high fidelity amplifier

amplitude, or all the gain possible, at the same time he must keep the overall response curve correctly proportioned and adjust the a-f-c circuit for correct operation.

FUNDAMENTALS STATED

Almost a year ago the serviceman was given a new tool to aid in this work, the oscilloscope using the inexpensive 913 cathode ray tube. A companion unit, the frequency modulated signal generator, was soon developed, making the task of alignment accurate and easy for the first time.

Since the practical application of any instrument demands a knowledge of certain principles of its operation, a brief review of the theory of these two units is in order. These fundamental principles are not new, nor are they offered in an original way. They are simply necessary if a discussion of practical uses is to be complete. First consider the oscilloscope.

The cathode ray tube may be thought of as a gun, shooting a stream or beam of electrons in such a way as to cause them to strike a glass screen. This glass is coated with a material which fluoresces when an electron beam hits it, thus producing a spot of light. Varying the voltage applied to control grids within the tube will vary the brilliance and quality of this spot of light by controlling the power of the electron beam. It will not be necessary to consider all the factors that control this "intensity" and "focus," since we are assuming that the serviceman has some knowledge of this subject. The beginner is urged to read a good text on this subject if he has not already done so, since a thorough knowledge of the various factors involved is necessary if one is to obtain the maximum use of his oscilloscope.

CONTROL OF THE BEAM

The heart of the cathode ray tube consists of two sets of plates arranged in opposite planes.

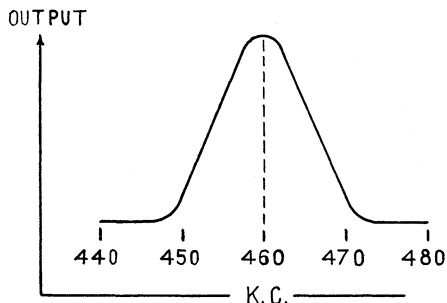

FIG. 1

While the vertical rise and fall is produced by the unknown voltage, the synchronizing voltage moves the beam horizontally. The resultant wave form is shown.

are helpless. On the other hand, a correctly aligned receiver will respond to the wishes of the operator, bringing in the desired program with clarity, naturalness and almost uncanny realism.

The introduction of these new circuits has greatly complicated the alignment procedure. At one time a signal generator or oscillator was a luxury to the serviceman and maximum volume the only result sought. Now he must strive for

By Leland S. Hicks

Thordarson Electric Mfg. Co.

(This discussion will deal only with the electrostatic method of beam deflection, since this is the only type tube that will be encountered in general service practice.) Adjacent plates from each set are tied together internally and grounded. The electron beam mentioned above passes through the square formed by these four plates.

From a previous knowledge of the action of vacuum tubes it is known that electrons are attracted toward a positive electrode. Using this principle, a positive potential applied to either of the free deflection plates will cause the electron beam to be attracted by it. The amplitude or degree of this attraction will be determined by the value of positive potential applied. It can easily be seen that the beam can be controlled in either a vertical or horizontal direction, or more important yet, in both directions at once. This, in brief, is the cathode ray tube. Now for its application.

In its present form, just a tube and power supply, the cathode ray tube is very limited in

amplifier for the signal applied to both the vertical and horizontal deflecting plates. Some manufacturers use a duo-triode tube for this purpose while others use an independent tube for each circuit. Through their use it is possible to study very small values of signal, controlling the amplitude of the image on the screen with a volume control.

LINEAR SWEEP AVOIDS DISTORTION

The one remaining need of the serviceman is a linear time base, a method for studying a signal that recurs repeatedly in a definite cycle or length of time. In the beginning it was shown that applying a positive potential to either deflection plate would change the position of the spot of light by a value proportionate to the value of the voltage and the sensitivity of the cathode ray tube.

It is customary to consider the horizontal plane of a graph as the time base, so this linear sweep is applied to the horizontal plates of the tube. The linear sweep gets its name from the fact that this horizontal voltage must vary

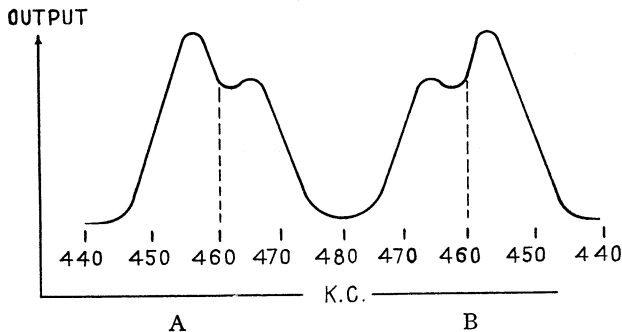

FIG. 2

One sweep takes place while the frequency changes from 440 to 480 kc (see A), while the other moves the frequency from 480 back to 440 kc (B). The object is to coincide these.

its practical application. Through the use of the manufacturers' data it is possible to calibrate the screen of the tube in terms of inches deflection per volt and use it as a very sensitive voltmeter for d-c measurements; percentage modulation of a transmitter may be determined by the trapezoid method or the oscilloscope may be used to compare and analyze frequencies.

USE OF 60 CYCLE SWEEP

The addition of a 60 cycle sweep is simply and easily done and will increase the usefulness of the unit still further. Connecting a 60 cycle voltage across the horizontal plates of the tube is all that is necessary. This simple addition permits a study of hum in receivers, or of percentage modulation by the envelope method. So far as the serviceman is concerned it is still impossible to make enough tests, since he is dealing with voltages too small to give a noticeable deflection and because he lacks one more sweep feature.

The lack of sufficient deflection per volt is remedied by the addition of an amplifier. Almost all oscilloscopes on the market today have an

equally with time for the forward movement, with practically no return trace, if distortion of the image is to be avoided. The sweep voltage must change from a given voltage value to a greater value at an even rate, then snap back to the original value immediately to begin its increase all over again. Pictorially this would appear as a saw tooth, with the voltage increasing at an even rate, or in a straight line, then dropping abruptly to the minimum value, each rise occurring in exactly the same time as the last.

On the screen of the tube this would appear as a straight line, since this rise and fall of the voltage would be at a frequency faster than that needed for visual persistence. The charge and discharge of a condenser through a gas-filled triode produces approximately this linear effect, the frequency being governed by the value condenser used and ranging from as low as 15 to as high as 30,000 c.p.s. Under some conditions it is necessary perfectly to synchronize this sweep voltage with the signal being applied to the vertical plates, so provision should be made to feed an external synchronizing voltage into

(Continued on following page)

(Continued from preceding page)
 the grid of the 885 linear sweep tube. This external synchronizing voltage differs from that applied directly to the horizontal plates of the cathode ray tube in that it triggers the 885 control tube and insures the approximately linear sweep being in exact synchronism with the oscillator rather than acting directly as a sweep voltage. This difference will be noticed

with the r-f sweep, or supplies an external synchronizing sweep, depending upon whether double or single image alignment is desired.

CONNECTIONS TO THE RECEIVER

In the discussion of the oscilloscope it was pointed out that a voltage applied to either of the deflection plates would cause the spot of light to move toward that plate. Every

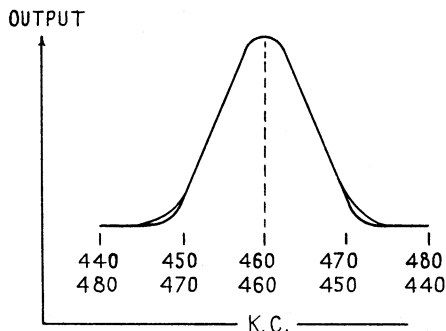

FIG. 3

The two curves coincide when the voltages are balanced.

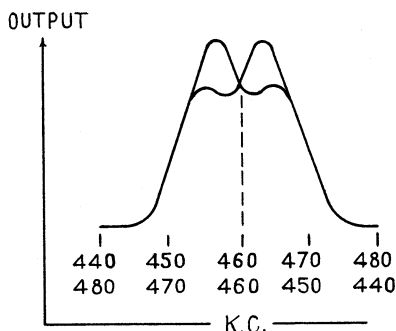

FIG. 4

There will be no coincidence if the two components of the wave are unbalanced.

when aligning the r-f and i-f section of receivers.

The completed 'scope, with amplifiers for both deflector plates, with provision for either 60 cycle, linear or an external sweep, and for an external synchronizing voltage, is fully equipped for any analysis that will arise in the service shop or ham shack, including the r-f and i-f alignment of receivers.

THE R-F OSCILLATOR

There are several types of frequency modulated r-f oscillators on the market today. Some manufacturers, such as Clough-Brengle, R.C.A., Supreme etc., keep the oscillator, the frequency modulator or "wobbulator," and oscilloscope separate or combine the wobbulator as part of the r-f oscillator. Some offer the wobbulator in conjunction with an oscilloscope, the Triumph Model 77 and the unit offered by the Earl Weber Company being examples of this type construction. Still another concern combines oscilloscope, signal generator and wobbler.

Regardless of the physical arrangement, they must have some method of offering the receiver under test a wide range of frequencies spread out on either side of the desired resonant frequency. For example, an i-f circuit may require alignment at a frequency of 460 kc. The frequency modulated oscillator must feed a sweeping signal, changing from 440 to 480 kc, to the i-f input at an audio frequency fast enough to overcome visual persistence when the spot moves across the surface of the 913 screen.

The wobbulator unit must also generate a synchronizing voltage which either triggers the saw tooth sweep in the 'scope in synchronism

with the r-f sweep, or supplies an external synchronizing sweep, depending upon whether double or single image alignment is desired.

The frequency modulated output of the r-f oscillator is fed to the circuit under test, either the i-f or r-f amplifier, through suitable coupling condensers to the i-f or through a 200 ohm resistor to the r-f sections. The synchronizing pulse generated by the wobbulator is fed to the horizontal deflection plates. As the oscillator sweeps the signal across the tuned circuit, the output voltage rises or falls, causing a vertical rise and fall of the spot of light in the oscilloscope. At the same time the synchronizing voltage causes the light to move horizontally in synchronism with the frequency. The resultant is a wave form similar to Fig. 1.

COMPROMISE IN PRACTICAL

If the spot of light moves across the face of the cathode ray tube in a horizontal plane twice, each time the frequency goes from minimum to maximum and back to minimum, two curves will have appeared on the screen. One horizontal sweep takes place while the frequency changes from 440 to 480 kc and forms the curve shown in Fig. 2A. The second sweep must begin at 480 and go back to 440, so the curve of Fig. 2B would result. These curves are formed at a speed fast enough to overcome visual persistence, so the two curves would actually appear one on top of the other. If the circuit is balanced so that the voltage generated in

going from 440 to 480 kc is the same as that when going from 480 to 440 kc, the two lines will coincide and appear as in Fig. 3. If they are not perfectly balanced, the waves will not coincide, as in Fig. 4. The serviceman then

on the screen. Most of the early "wobblers," such as the R.C.A. units, were designed for this method of alignment.

A calibrated screen is necessary for single image alignment, with a sample curve traced

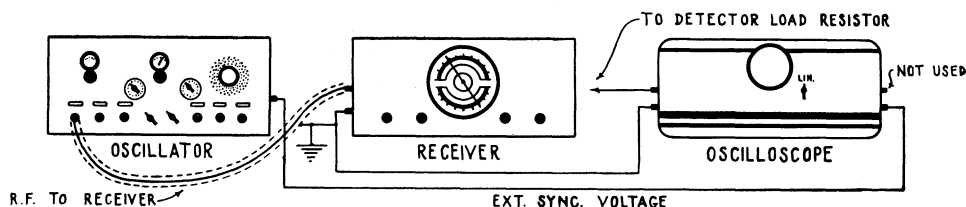

FIG. 5

Alignment by the double image method. The 'scope's sweep is at "Linear". The signal generator (oscillator) determines the frequency.

adjusts the i-f or r-f trimmers until the two lines coincide and are symmetrical.

In practice it may be impossible to achieve perfect coincidence, one side being slightly different from the other. You should adjust the set to come as near to this as possible and keep the curves symmetrical. In receivers with variable selectivity i-f's, the switch should be in the "Selective" position until all i-f adjustments are completed. Then turn the switch to the "Fidelity" position and make any slight readjustments necessary to even up the "humps" of the flat top. Just follow the set manufacturer's instructions for i-f alignment, but make adjustments for a correct curve on the 'scope rather than a maximum reading of the output meter.

This is the double image method of alignment. Typical connections between the oscillator, the 'scope and the receiver are shown in Fig. 5. If the frequency modulated oscillator is a Clough-Brengle O.M.A. or the new 111 electronic modulated unit, or an R.C.A. No. 150, you will use the double image method of alignment.

When aligning by the single image method, the receiver, oscillator and oscilloscope are connected as shown in Fig. 6, the selectivity switch being in the same position as for double image alignment. The synchronizing sweep voltage from the wobbler is applied to the horizontal trace, this sweep voltage is shorted out as the oscillator changes from 480 to 440, or for half the r-f sweep cycle, so only one curve appears

input of the oscilloscope and sweeps across the screen of the 913 just once for each r.f. sweep, resulting in two single traces. In the true single upon it. The serviceman adjusts the various trimmers until the best height and symmetry of the curve are obtained, all the time trying to simulate the curve drawn on the calibrated screen.

ATTEMPT AT SIMULATION

It is easier to make two curves coincide than to make a single curve accurate, so the double image method of alignment is becoming the more popular with the service man. The chances for error are less than half as great as with the other method. After all, the usual serviceman is not equipped to redesign a receiver if the response curve is not just what he wishes. He must align the receiver to the best of his ability within the limits set by the manufacturer and be satisfied. Very few owners want their receivers redesigned, nor would they pay for the necessary expense involved. Nevertheless, the serviceman is urged to study and understand the uses of both methods.

PRACTICAL HINTS

The i-f stages should be aligned in reverse order, connecting the signal source to the grid of the tube nearest the second detector first and working back to the first detector. This keeps
(Continued on following page)

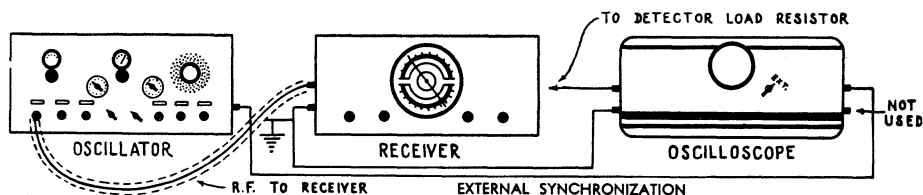

FIG. 6

The connections for the single image method. Sweep of the 'scope is at "External".

List of Stations for Checking Frequencies

SHORT-WAVE stations are not only valuable for the programs and messages they send forth but also some of the transmitters maintain their frequency with exceptional accuracy and may be used as standards. Thus servicemen, knowing the station frequencies, can calibrate generators, aided if need be by harmonics of the generator, and also align the receiver at the r-f and oscillator levels, on the basis of the station it receives, no generator being required for this.

A selected list of stations, mostly in the East, has been compiled by Radio Manufacturers Association, Inc., grouping stations by cities, giving call, chain affiliation, schedule of hours on the air in E.S.T., frequency in kilocycles (Kc) and equivalent wavelength in meters (M), as follows:

Boston—W1XK (NBC)			
Daily (except Sunday)	6:00 a.m.- 1:00 a.m.	9,570	31.3
Sundays	8:00 a.m.- 1:00 a.m.	9,570	31.3
Boston—W1XAL			
Daily (except Sunday)	2:30 p.m.- 4:30 p.m.	15,250	19.6
Daily (except Sunday)	5:00 p.m.- 6:30 p.m.	11,790	25.4
Sundays	10:15 a.m.-12:00 noon	15,250	19.6
Sundays	5:00 p.m.- 7:00 p.m.	6,040	49.6
Chicago—W9XAA			
Daily (except Sunday)	6:00 a.m.- 7:30 a.m.	6,080	49.3
Daily, including Sunday	7:00 p.m.-10:00 p.m.	6,080	49.3
Chicago—W9XF (NBC)			
Daily	5:00 p.m.- 8:05 p.m.	6,100	49.1
Daily	12:05 mid.- 1:00 a.m.	6,100	49.1
Cincinnati—W8XAL			
Daily (except Sunday)	6:00 a.m.- 8:00 p.m.	6,060	49.5
Daily (except Sunday)	11:00 p.m.- 2:00 p.m.	6,060	49.5
Sundays	8:00 a.m.- 8:00 p.m.	6,060	49.5
New York—W3XAL (NBC)			
Daily (except Sunday):			
Direction Europe.	9:00 a.m.- 6:45 p.m.	17,780	16.8
Direction Central & South America	7:00 p.m.- 9:00 p.m.	17,780	16.8

Direction Central & South America	9:15 p.m.- 1:00 a.m.	Kc	M
		6,100	49.1
Sundays:			
Direction Europe	9:00 a.m.-12:00 noon	17,780	16.8
Non-Direction Europe	12:15 p.m.- 6:45 p.m.	17,780	16.8
Direction Central & South America	7:00 p.m.- 9:00 p.m.	17,780	16.8
Direction Central & South America	9:15 p.m.- 1:00 a.m.	6,100	49.1
New York—W2XK (CBS)			
Daily (except Sunday):			
Direction Europe.	7:30 a.m.-10:00 a.m.	21,520	13.9
Direction Europe.	3:00 p.m.- 5:30 p.m.	15,270	19.6
Direction Europe.	6:30 p.m.- 7:00 p.m.	11,830	25.3
Direction South America	10:00 a.m.-10:30 a.m.	21,520	13.9
Direction South America	5:30 p.m.- 6:00 p.m.	15,270	19.6
Direction South America	7:00 p.m.-12:00 mid.	11,830	25.3
Sundays:			
Direction Europe.	8:00 a.m.-10:00 a.m.	21,520	13.9
Direction Europe.	1:00 p.m.- 4:00 p.m.	15,270	19.6
Direction South America	5:00 p.m.- 6:00 p.m.	15,270	19.6
Direction South America	7:00 p.m.-12:00 mid.	11,830	25.3
Philadelphia—W3XAU (CBS)			
Monday, Tuesday, Friday & Saturday	12:00 noon- 8:00 p.m.	9,590	31.2
Monday, Tuesday, Friday & Saturday	8:00 p.m.-11:00 p.m.	6,060	49.5
Wednesday & Sunday	12:00 noon- 7:00 p.m.	9,590	31.2
Wednesday & Sunday	8:00 p.m.-11:00 p.m.	6,060	49.5
Thursday	12:00 noon- 8:00 p.m.	9,590	31.2
Thursday	8:00 p.m.-10:00 p.m.	6,060	49.5
Thursday	10:00 p.m.-11:00 p.m.	9,590	31.2
Pittsburgh—W8XK (NBC)			
Daily	7:00 a.m.- 9:00 a.m.	21,540	13.9
Daily	9:00 a.m.- 7:00 p.m.	15,210	19.7
Daily	7:00 p.m.-10:00 p.m.	11,870	25.2
Daily	10:00 p.m.-Sign off	6,140	48.8
Schenectady—W2XAD (NBC)			
Daily	11:00 a.m.- 9:00 p.m.	15,330	19.5
Schenectady—W2XAF (NBC)			
Daily (except Saturday)	4:00 p.m.-12:00 mid.	9,530	31.4
Saturdays	12:00 noon-12:00 mid.	9,530	31.4

Detector Load Altered for Alignment

(Continued from preceding page)

the preceding stages from disturbing the one under test.

If the detector load is an impedance or a transformer, change it to a resistance load by using a 25,000 ohm resistance for a plate load, and bypassing the plate inductance with a 1 mfd. condenser. Take the voltage for the vertical plates of the oscilloscope from across this resistor.

Many experienced servicemen use the oscilloscope to align only the i-f and broadcast r-f circuits. If the i-f transformers are correctly aligned, the high frequency stages can only be adjusted for maximum amplitude of the signal.

An output meter and an r-f modulated signal generator can be just as efficient and possibly do faster work. It is the alignment of the i-f transformers that is the more important. The 'scope is used to align the broadcast band since its use permits correct padding of the low frequency end without "rocking in" as is usually done.

Careful study of the principles of the oscilloscope, plus experience in its use, will make it an indispensable piece of equipment and it will more than pay for itself. Above all, dramatize its use, let your customer know you have the latest equipment and sell him on the idea of paying a few cents more for an expert job of alignment.

New Type Cabinet Developed

Hammarlund "Super-Pro" Uses Bass Reflex

By Lewis Winner

AFTER almost a year of development and engineering research, the Hammarlund Mfg. Co., Inc., has devised a new type of high-fidelity console to house the popular "Super-Pro." The professional performance provided by this precision instrument, heretofore available only in the table model or rack and panel style, thus now can be enjoyed with the receiver in a family type housing.

The console is exceptionally attractive, being of the classic-modern style made of burl, matched and Oriental walnut artistically blended. Also the console has remarkable acoustical properties skillfully developed, thus matching the other professional features of the "Super-Pro" receiver. To achieve this brilliant acoustical performance, a bass reflex sealed sound chamber with a 15" high-fidelity speaker has been incorporated in the console.

CABINET PROBLEM

It is well known that the general run of radio cabinets has many recognized disadvantages. For instance, they certainly permit very little low frequency response. In some console cabinets, we do have some bass response which occurs between approximately 120 and 150 cycles and in table type cabinets between 140 and 220 cycles which, of course, results in very loud boomy reproduction of both speech and many instruments. This sometimes serves to take the place of real bass response for the listener who is not critical, but it is well known that speech response is poor and that both speech and music are highly toned by this peaked effect.

It is, of course, possible to remove this boom by many methods, but this is inadequate unless the bass range is extended because reproduction of certain types of music will suffer from a deficiency in bass response.

The use of electrical compensation in a receiver is only slightly successful when the acoustical system is inefficient, because naturally excessive compensation limits the apparent output of the system. It is also well known that the low and middle low frequency response depends, to a great extent, upon the acoustical environment of the cabinet, that is, the distance of the cabinet from the wall, the absorption characteristic of the wall material and so on.

ENCLOSED SYSTEM USED

Most of the above difficulties can be charged to what may be termed a non-controlled rear radiation from the speaker. To remedy this,

the bass reflex system enclosure is used. This minimizes the short comings of a cabinet by controlling the backside radiation.

By proper design the low-frequency efficiency of the speaker is materially increased. The

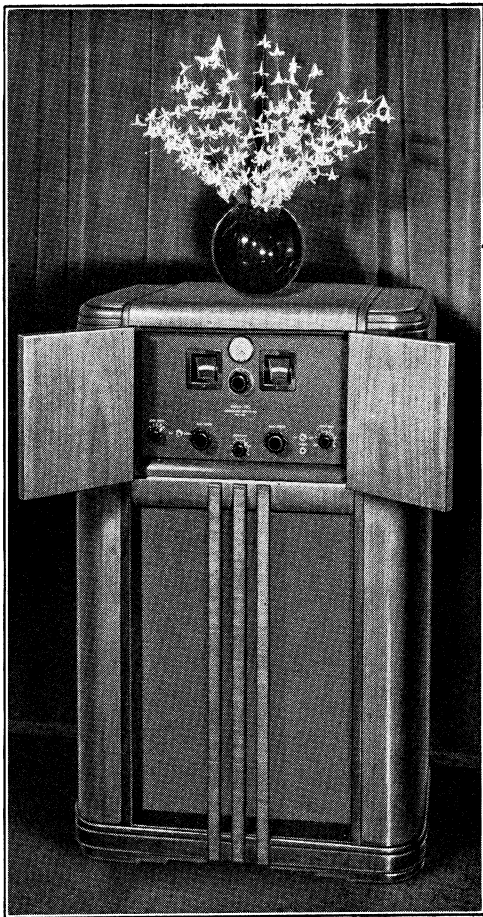

An originally-conceived console houses the "Super-Pro" in home surroundings.

marked resonant peak which makes speech boomy can be eliminated. In the bass reflex system, a higher degree of efficiency in the output range has been obtained than in any other
(Continued on following page)

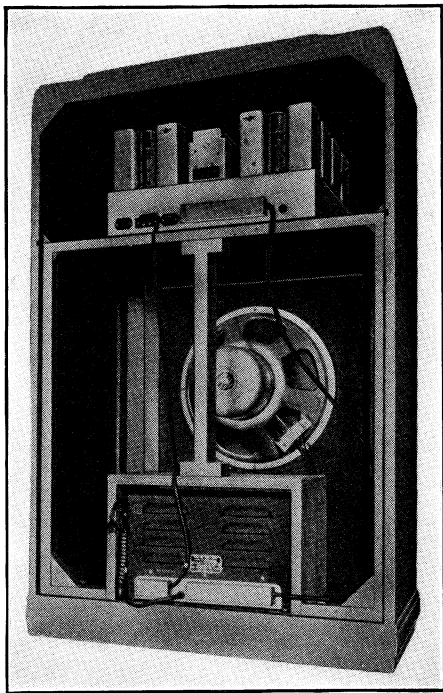

Rear view, with back cover removed.

(Continued from preceding page)

system heretofore designed to accomplish the same result.

The tremendous improvement provided by this system is very evident from a special test which was made, affording the results shown below:

Frequency (C.P.S.)	Open Back	Closed Back	Improvement
40.....	-18	+ 5	+13 db
50.....	- 6.5	+ 1	+ 7.5 db
60.....	+ 1.2	+ 4	+ 2.8 db
70.....	+ 1.0	+ 6	+ 5.0 db
80.....	- 3.5	+ 7.5	+11.0 db
90.....	0	+ 8.5	+ 8.5 db
100.....	+ 5.5	+ 8.5	+ 3.0 db
110.....	+ 8	+ 8	0 db
120.....	+10	+ 7	- 3.0 db
130.....	+10.5	+ 6.5	- 4.0 db
140.....	+10	+ 6	- 4.0 db
150.....	+ 9	+ 5.5	- 3.5 db
175.....	+ 7	+ 5	- 2.0 db
200.....	+ 5	+ 5	0 db

EFFECT ANALYZED

The effect from 40 to 100 cycles is very advantageous because it definitely brings up the real bass response. Between 120 and 200 cycles the effect is also very advantageous because this removes the boominess or so-called cabinet resonance. The bass reflex system is effective in extending the range of the loudspeaker approximately an octave. The port or rectangular opening located beneath the loudspeaker opening which is a feature of the bass reflex system behaves as an auxiliary diaphragm.

The large size speaker used provides the effective diaphragm area to afford quality reproduction.

The "Super-Pro" receiver used in this console is identical to the standard model made for table model or rack and panel, except for two slight modifications to simplify tuning. One of these is the removal of the variable beat oscillator control, but the c.w.-modulation switch has still been retained. The other is the removal of the standby switch. Both of these features, while important to the amateur or professional operator, are not necessary for home use. All the other important advanced features such as variable band width (3 to 16 kc); electrical bandspread; fractional microvolt sensitivity; a-v-c-manual switch; calibrated audio and sensitivity controls; direct tuning, accurate to within $\frac{1}{2}\%$; self-contained tuning unit with the fool proof cam operated knife switch; tropic proofed chassis; 8 metal and 8 glass tubes; two tuned r-f stages on all bands; tuning meter, and so on, have all been retained.

Three models for three tuning ranges are available for $7\frac{1}{2}$ to 240, 15 to 560, and 15 to 2000 meters. The console is $29\frac{3}{4}$ " x 18" x $44\frac{1}{2}$ ".

SHORT SHOTS

It is only natural that a condenser corporation like Cornell-Dubilier should operate its eleven buildings to full capacity.

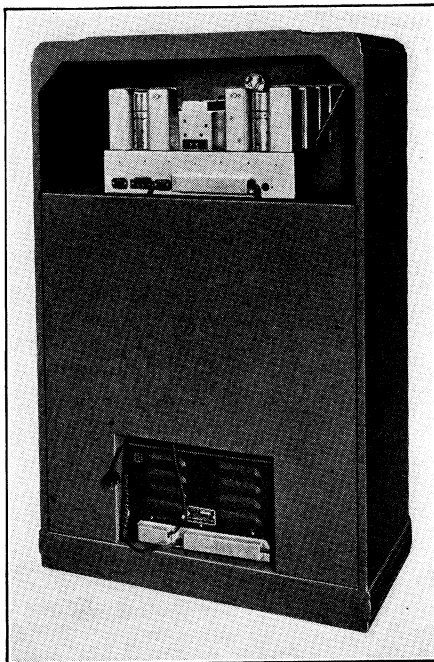

The closed rear of speaker housing, receiver above.

THE FEEDBACK LOOP

By Russ Forrester

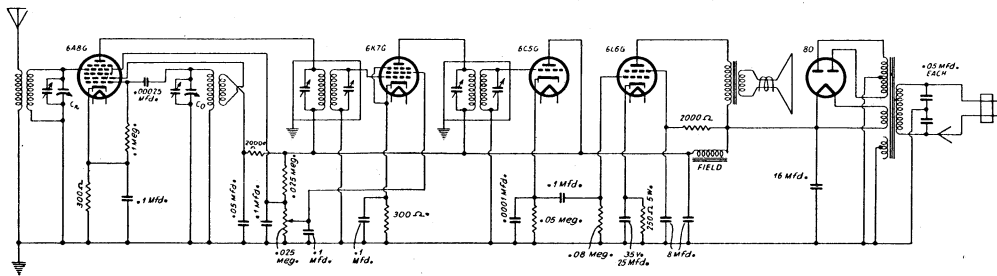

Coil second from left is the oscillation transformer.

FEEDBACK. What does it mean? How can you tell the right direction of connection, without actually trying a coil in a circuit?

Feedback is the return of energy from the output circuit to the input circuit in such a manner as to reinforce the input. This means that the voltages are alternating, also that they are in step, i.e., in phase.

What is the effect of feedback? When it is positive, as the type just described, then the effect is to augment greatly the amplification. That is another way of saying the sensitivity of the system is much increased.

The local circuit around which the feedback takes place is known as the feedback loop.

HIGH FREQUENCY FREAK

It is a strange fact that the phase of the grid voltage shifts so much at the very high frequencies that the tube, of course, no longer represents a 180 degree phase difference, such as normally obtains, and the feedback coil has to be connected the "wrong" way to produce oscillations. In any high or ultra frequency experiments with oscillators, always bear that odd fact in mind.

The circuit shows a superheterodyne diagram, but what we are interested in is the local oscillator. There it is, just to the right of the first tube, secondary at left tuned by a variable condenser, primary (or tickler) at right, with ends crossed over in some way, and for what reason?

Consider a two-winding coil, called a transformer. It has a primary and a secondary. The primary may have more or fewer turns than the secondary. In the oscillator circuits we use, the secondary, in the tuned circuit, has more turns. We know therefore that the small winding is the feedback coil, or tickler.

DIRECTION OF WINDING

If we look at the coil, and imagine we are winding it, we may trace the wire from the beginning (far end of either winding), and follow the direction in which the wire was put on. When we come to the adjoining winding we find that it was put on in the same direction. Thus the two windings are related

to each other by (a) mutual inductance, and (2) direction of winding. One may say that the windings are in phase.

Now if we connect the far end of the secondary, which will be near the end of the tubing on which the coil is wound, to the grid circuit, and the end of that winding to ground, we can tell in which polarity to connect the tickler to produce oscillation. The reasoning is as follows:

The tube inverts the phase 180 degrees. Therefore, if the grid winding has a voltage of given phase, the plate circuit voltage will be out of phase by 180 degrees. The plate winding must carry a-c in phase to reinforce the grid. Since the plate coil is wound in the same direction as the grid coil, if the plate is connected as the grid, then the coil will introduce no change, and there will still be the same 180-degree out-of-phase condition, no oscillation, only negative feedback.

REVERSED CONNECTIONS

We could unwind the tickler and put the wire on in the opposite direction. Then there would be oscillation, with connections in the same sense. But we don't have to do that. It is to the same effect to connect the feedback circuit to the tickler 180 degrees out of phase. How? By reversing the connections to the tickler, compared to those to the grid coil. So, one end of secondary, far end, near outside end of coil form, went to grid, and to give opposite effect in the similarly wound plate coil, instead of connecting the same relative terminal of the tickler to grid, we connect it to B plus. Thus, the connections, reading from outside secondary, along the windings, would be grid, ground, B plus and plate. For coils wound in the same direction an easy rule is that the low potentials adjoin, inside. These are ground and B plus. Grid and plate connections are "outside." Radio-frequency potentials are meant, of course.

Therefore in the diagram, the crossover of the leads from the tickler means commercial or instructed coils, primary and secondary, are wound in the same direction, and should be connected in reverse to institute oscillation.

NEW TUBES GIVE SHORT WAVES A LIFT

Results Far Exceed Those from Pentagrid Converters

By H. J. Bernard

RADIO rapidly acquired an industrial status due to developments that pivoted almost entirely around the standard broadcast band. Then a gradually increasing interest in short-wave reception became abruptly large and put the single-band receiver in the minority. There were three bands normally, one the standard broadcast, the others the intermediate short wave in two steps. Later the frequencies lower than those in the broadcast band were exploited, as for weather reports, also some attempt made at the reception of ultra frequencies or really "short" waves. An effort was made to distinguish between the two short-wave groups, by referring to the lower frequencies as intermediate short waves and the higher as short waves. There is still confusion, with no definite lines of demarcation for the whole spectrum, although efforts are being made by trade and scientific associations to settle on a definite classification and terminology.

The mere statement that a receiver covers three bands, or a total span of 530-22,000 kc, does not disclose how well or how poorly it performs on any of them. The standard broadcast band invites the most confidence. The higher frequencies introduce difficulties not always completely in hand.

Radio has been rather slow in developing to the point where reception is made to conform to a high standard. More than ten years were required before receivers began to appear that were well worth listening to, and a few years more before true reality was obtainable. Both transmitters and receivers had to be built to certain high standards before the phrase "high fidelity" acquired any genuine significance. Even now it is used very carelessly, and mere description of a receiver as being of the "high fidelity" type is less than full assurance that the receiver yields the desired exacting results.

Along with the attainment of better quality of reception through receiver improvements, a gradually ascending trend to which the better stations are contributing a great deal by lofty type symphonic transmissions, is the effort toward improved results on other than the standard broadcast band.

It used to be almost axiomatic to include a pentagrid converter tube in a superheterodyne

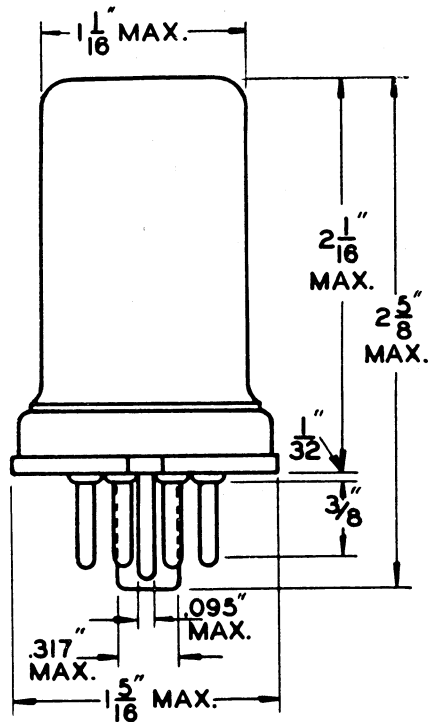

TUBE AND BASE DIAGRAM
(BOTTOM VIEW)

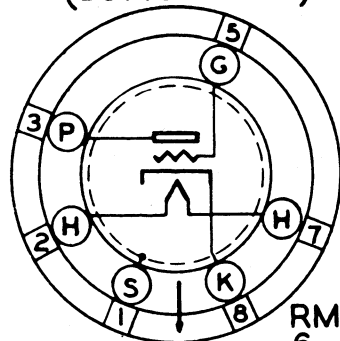

RMA
6-Q

Sylvania

The 6J5 is a new metal tube that performs like the 6J5G and is therefore good for high radio frequencies.

receiver, as a matter of economy, but as higher and higher frequencies are tuned in, the receiver is found to be less and less effective. It was more satisfactory, though costly, to include a separate oscillator tube, which afforded an extra means of allotting the degree of coupling between the local oscillator and the modulator tube in a super's mixer circuit. This extra leeway enables better sensitivity and selectivity at frequencies in which the pentagrid converter tube works, and moreover permits reception at frequencies higher than other method.

THE TUBE OUTPUT CAPACITY

One of the factors compelling limitation of satisfactory results to some particular high frequency is the output capacity of a tube, normally around 12 mmfd., which presents a sizable conductance to these high frequencies. Therefore part of the currents intended to go into the normal operation of the tube is bypassed to ground from the output circuit. It was naturally advisable to reduce the output capacity, to permit increase of the output capabilities at these high-frequency levels. This has been done in the so-called acorn tubes, made especially for frequencies above 30 mc (waves below 10 meters), and even permitting results to below one meter, but these tubes are necessarily expensive, because difficult to make and of limited market due to the cost, and need not be included in sets intended to stop at 5 meters. However, some progress has been made in producing tubes of lower output capacity than 12 mmfd. and also of increased mutual conductance, or transconductance.

The output capacity is easily understood to be the capacity between plate and cathode. Since the cathode is normally grounded to radio frequencies, the capacity is the same as that between plate and ground. Hence the output circuit is shunted by an unintended and undesired condenser, and the goal is to keep the capacity of this condenser as low as possible. Instead of the 12 mmfd. output capacity, therefore, we have tubes at the usual low prices that prevail for receiver tubes, with output capacity of less than 4 mmfd., or one-third that of the usual run of tubes. For a triode the other capacities might be approximately 3.4 for grid to plate and the same for grid to cathode.

THE TRANSCONDUCTANCE DEFINED

However, the transconductance is something that concerns the current in the operating tube, when the direct-current voltages are applied. Transconductance is the ratio of the change in the current in the circuit of an electrode to the change in the voltage in another electrode, all other voltages remaining unchanged. For closeness of determination, very small changes only are involved. Therefore considering the plate circuit and the grid circuit, the plate current change is measured while the measured grid voltage is changed only a very little, and we have the grid-plate transconductance. The formula is:

$$S_m = \frac{d I_p}{d E_g}$$

the symbols being S_m for transconductance, d for difference, I_p for plate current and E_g for grid voltage.

The disposition of the numerator and the denominator being remembered, some workers refer to the formula as "dipdeg."

Now this conductance is the figure of merit of an oscillator tube, and the same tube that has been endowed with a relatively small output capacity also has been designed for a relatively large grid-plate transconductance, for instance, 2,600 micromhos, instead of around 2,000. This means the tube is a better oscillator, and better intensity obtained at high frequencies, when the combined advantages of the tube are considered.

The tubes with which servicemen are most familiar, because encountered frequently in daily practice, are not of the improved high-frequency type just discussed. Also, the newer tubes work as well or better at the lower frequencies, so that the improvement at one end of the spectrum is not at the expense of the other end.

RECEPTIONLESS RECEPTION

The improved tubes may be used as amplifier, oscillator or detector, but the chief advantage would be as oscillator, because the improvement is considerable, whereas for detection or amplification, other tubes may be as good, and in some instance, even better, considering short waves.

Results at frequencies higher than, say, 25 mc, are not remarkable on the run of commercial receivers, for if they were there would be small need for the special types of receiver designed for such service. The amateurs, for instance, who prefer their receivers factory-built, because, they unblushingly admit, better engineering is thus attained where highly specialized equipment is adamant, get small comfort out of frequencies higher than 25 mc, on ordinary sets, and yet they often want to listen to 5 meters (60 mc), a region in which the run of commercial receivers, if they are advertised to include such a band, usually give most disappointing results.

The author has tuned quite a few general receivers, but having other things to do, and perhaps sufficient patience, or not working the set right next door to a transmitter, hear nothing on 5 or 10 meters. Others in the neighborhood, tuning specialized receivers, did bring in stations on the same band. Persons to whom he has spoken have remarked about the "10 meter band being dead on my set." It is not to be expected that the formal superheterodyne will cover well all the usual bands, and then perform as well in the ultra field. But it is to be expected, I hope, that the ultra bands will be omitted from receivers unless results can be obtained.

NOT TUBES ALONE

It has been almost the rule to set forth excessive claims for receivers, especially as the public is addressed in strange terms, and the technical phrases are overpowering to a lay-
(Continued on following page)

Literature Wanted

Readers whose names and addresses are printed herewith desire trade literature on parts and apparatus for use in radio construction. Readers desiring their names and addresses listed should send their request on postcard or in letter to Literature Editor, Radio World, 145 West Forty-fifth Street, New York, N. Y.

William Hansen, 227 Main Street, Niles, Mich.
 Ricardo M. Suarez Bengochea, Riviera Ludaste 48, Buenos Aires, Argentina.
 W. W. Brigham, 1595 Lincoln Ave., Lakewood, Ohio.
 Frank P. Defina, 554 N. Vine St., Hazleton, Penn.
 Edward Kulwitz, 1334 Wicker Park Ave., Chicago, Ill.
 Kent Sabre, 1260 Broadway, San Francisco, Calif.
 Geo. W. Hoskinson, Glendale, Ky.
 John Binder, Jr., 1025 9th St., Phoenix, Ariz.
 R. H. Swinford, P. O. Box 456, Napa, Calif.
 Orrin H. Carpenter, 118 South Main St., Waterbury, Vt.
 Miles I. Hart, P. O. Box 76, Cary, N. Carolina.
 Frank J. Billiams, W21K1, 511 E. Platte Ave., Colorado Springs, Colo.
 Frank S. Walters, W5J9, 4105 Wisconsin Ave., N.W., Washington, D.C.
 George Francis Baptiste, W3G8, P. O. Box 114, Howard, R. I.
 Kenneth E. Vroom, 44 Glenbrook Rd., Morris Plains, N. J.
 D. A. Griffin, 21 Rockview Ave., North Plainfield, N. J.
 Luis Gandia, Jr., Mayaguez, P. R.
 B. H. Hansen, Milford, Neb.
 47 Lynwood Ave., Wheeling, W. Va., c/o C. S. Hoffmann, Jr.
 Russ F. Sievert, 1345 East 66th St., Cleveland, Ohio.
 J. H. Crumley, Elyria, Ohio.
 Bill Batchelder, 184 So. Main St., Manchester, Conn.
 Carroll H. Weyrick, 4310 Evans Chapel Rd., Baltimore, Md.
 Joseph Werner, 320 River Ave., Camden, N. J.
 E. G. Bowden, 205 S. 3rd St., Albuquerque, N. Mexico.
 C. F. Temby, W9VOV, Kewaunee, Wisc.
 Harry O. Jones, 5021 W. 21st St., Los Angeles, Calif.
 W. B. Guilmont, W9JID, Champlin, Minn.
 W. Cox, 2030 N. Penn. St., Indianapolis, Ind.
 Braden Engineering Co., 305 Park Drive, Dayton, Ohio.
 R. H. Lynch, 970 Camulos, Los Angeles, Calif.
 F. R. Gossett, Box 3, 7460 Beverly Blvd., Los Angeles, Calif.
 Leo Larkin, Federal Bldg., Sioux City, Ia.
 H. H. Clewett, San Dimas, Calif.
 Frank C. Jones, 2037 Durant Ave., Berkeley, Calif.

(Continued from preceding page)

man. Models a year or so later may possess the virtues claimed for their predecessors. Less and less of this pressure campaigning is going on, as the industry becomes more nearly stabilized, although it is far from real stability yet. Those, however, who have a special interest in the ultra frequencies know well that to receive on this band requires a special set and therefore usually have a separate receiver for this purpose.

More than a tube problem is at stake, of course. If all that were needed were an extra tube for independent local oscillator, of the high transconductance, low output capacity type, that would be included. But the other problems concern coils, condensers, resistors, placements, filtering, shielding, etc., in a complex combination, and requiring adroit engineering.

Much of radio's advance in the immediate future will be on ultra frequencies.

AWAITING TELEVISION

It is just such an ultra-wave receiver that will be necessary for television reception, because of the wide bandwidth required to permit a picture of good detail. When the day of commercial television arrives, special ultra-frequency tubes, perhaps of the acorn type, may be expected in the front end of receivers.

Meanwhile those experimentally inclined may follow orthodox circuits, using separate oscillator and modulator tubes, and have one of the improved receiver tubes, such as the 6J5G or the 6J5, at least as local oscillator. The 6J5G is a glass type with octal base, and aside from the two improvements, parallels the 37, 76, 6C5 and 6C5G. The 6J5 is a very recently announced companion tube, but in the all-metal class, with octal base, pin No. 4 being omitted. For 250-volt operation, if a plate load resistor is used, it should be 50,000 ohms, with negative grid bias of 5.5 volts (cathode bias resistor, 2,300 ohms), or for 100-volt operation, load resistor 30,000 ohms, negative grid bias 2.3 volts, (cathode bias resistor, 1,500 ohms). The figures were supplied by Sylvania.

Double Image Method Advocated

THE double-image method of alignment, as its name implies, requires a frequency-modulated r-f signal source and an oscillograph with a timing axis supply so synchronized with the frequency modulation of the r-f. signal that normally two resonance curves appear on the screen. When the response of the circuit being aligned by this method is symmetrical and at the proper frequency the two images completely coincide at all points, that is, the two images merge into one. Thus, correct alignment is very definitely indicated, and any departure from it is quite obvious or "thrown in the operator's face." An analogy may be made at this point.

Suppose it is desired to draw a "U" the sides of which are perfectly symmetrical about the center of the letter. One method would be to draw it on translucent paper, fold the paper at the center of the "U," and observe whether the two sides coincide. This may illustrate the advantages obtained by the double-image method of alignment, except that in the latter case the "folding-back," which is obtained by the super-position of the two images, is an automatic and continuous process.

The screen is like a transparent cylinder on which the image is projected, but image rotation is to be avoided.

The Pentagrid Converter's Internal Performance

The mixer circuit of a superheterodyne, with the grids given their identification numbers, and the three frequency levels indicated. Ingenuity in tube design causes mixture and isolation.

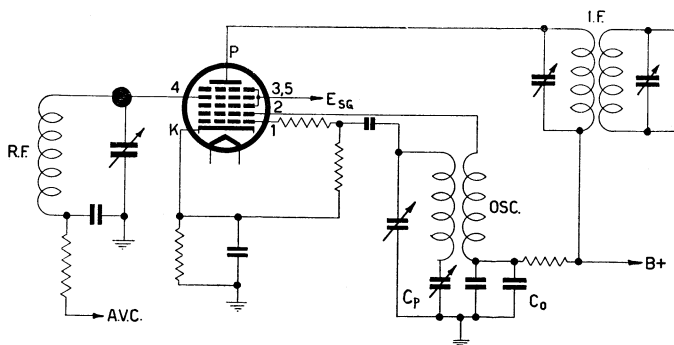

THE pentagrid converter may be considered as operating very much like a conventional variable mu tetrode first detector with an associated triode oscillator, except that the oscillator triode grid is located next to the cathode and is common to both the first detector variable-mu tetrode and the oscillator triode. The tetrode section of the tube is modulated by the control grid voltage on the oscillator triode in such a manner that there is no danger of driving the control grid of the tetrode positive. Electrons emitted from the cathode surface are influenced by the various grid and plate voltages and divide up so that grid No. 1 receives 7 per cent of the electrons, the oscillator anode receives 37 per cent of electrons, grids Nos. 3 and 5 (screen grid) receive 28 per cent of the electrons, and the plate receives the remaining 28 per cent.

Because of the oscillator grid's strategic position next to the cathode, any oscillator voltage on this grid will modulate the entire electron stream regardless of the ultimate destination of the electrons. Referring to diagram, it is interesting to observe the action that takes place within the tube when it and the associated circuit components are operating normally.

ACTION DESCRIBED

When the set is first turned on, the No. 1 grid is at zero potential because it is tied to the cathode by the 50,000 ohm grid leak, says George C. Connor, in "Sylvania News." As the cathode heats up and starts to emit electrons, the feedback between oscillator anode and grid causes regeneration which immediately

starts the triode circuit to oscillating. When the oscillator circuit is oscillating, the No. 1 grid is driven alternately positive and negative.

While the grid is positive, grid current flows through the grid leak in such a direction as to make the No. 1 grid negative with respect to the cathode. This grid swing may make the grid negative by as much as 30 to 40 volts, and this becomes the grid bias point about which the grid varies in amplitude alternately in a positive and then a negative direction under the influence of plate circuit feedback. From this it can be seen that the maximum instantaneous negative voltage on the No. 1 grid may be 60 to 80 volts. This voltage would ordinarily be more than sufficient to reduce the tetrode plate current to zero were it not for a secondary source of electrons available to the No. 4 grid. This second electron source is referred to as a virtual cathode because it is employed exactly as though it were another electron emitting cathode. The reason for its existence is that most of the cathode's supply of electrons go through the No. 1 grid while it has a positive or slight negative charge, and are accelerated out of the No. 1 grid's field of influence by the relatively high positive potential on the No. 3 grid.

AN ELECTRON CLOUD FORMS

The next grid—tetrode section control grid—has at all times a negative bias on it so that a great many of these electrons are slowed down and form a cloud of electrons between the No. 3 and No. 4 grid. It is from this cloud of electrons (virtual cathode) that most of the plate

(Continued on following page)

THE HAYNES POCKET RECEIVER

By George V. Dubuc

Douglas Radio

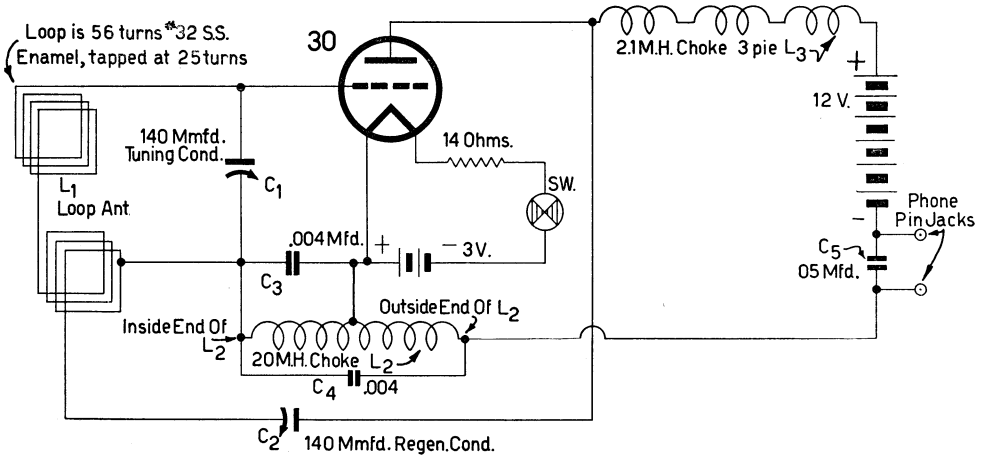

A super-regenerative circuit, with built-in loop for pickup, brings in "locals" well, is of pocket size, and may be used at outdoor sporting events to hear a broadcast announcer's description of play and identification of players.

HERE is a complete vacuum tube receiver including batteries and antenna which actually does fit in your pocket and permits reception of the local broadcast programs while concealed in the pocket. The controls are placed on the top edge of the case so that it may be tuned even in this position. This means that you can watch a football game, for instance, and listen to an expert's description of it at the same time. You know immediately who is carrying the ball; who made the tackle and what that penalty was for.

Best of all, the Pocket Receiver, designed by A. J. Haynes, is simple to put together and very inexpensive as there are so few parts involved. The filament current is so small—only .06 ampere—that even the two small flashlight batteries which are used have long life and besides cost only a few cents to renew.

SUPER-REGENERATION USED

The circuit is of the super-regenerative type,

(Continued from preceding page)
current is obtained during that portion of a cycle that the No. 1 grid is at its maximum negative potential. It is easy to see from this action that the tetrode section works independent of the triode section, except that the tetrode plate current is modulated by the triode grid voltage. The No. 3 grid shields the triode section from the tetrode section and prevents interaction.

which gives tremendous power sensitivity from a single tube. This type of circuit is very common in ultra-short wave receivers but is practically never used in the broadcast band as its tuning characteristics are too broad. This is no detriment, however, to a pocket receiver which is only intended to receive the comparatively local stations and uses a small loop antenna wound on the case.

The principal requirement is that the circuit used should be able to deliver a maximum of power from a very weak signal pickup; in other words "power sensitivity," and that is where the super-regenerative circuit shines. The tremendous sensitivity of this circuit can be appreciated when it is realized that only 12 volts of B battery are used (small pencil type flashlight batteries) and the antenna is wound around the circumference of the small case.

Even the case of the Pocket Receiver is easy to make. It is constructed from $\frac{1}{4}$ inch thick plywood fastened together with glue and
(Continued on following page)

The tetrode grid No. 4 is shielded from the plate by the other screen grid No. 5. Grids Nos. 3 and 5 are connected together inside the tube. Automatic volume control bias may be applied to the tetrode section without affecting the performance of the oscillator section, since the oscillator triode obtains its plate current first direct from the cathode.

This tends to prevent overload.

(Continued from preceding page)

brads. It is a plain rectangular box with inside dimensions of 7 by 3 $\frac{3}{4}$ by 1 $\frac{3}{4}$ inches. The front and back covers should be allowed to project about 1/16 inch beyond the sides to protect the loop antenna which is wound around the circumference. A plywood partition, 4 inches long, is placed inside to segregate the batteries. It is placed 1/16 inch on the tube side of the center line.

Other forms of container may, of course, be used in which case a little experimenting with the loop antenna to get the desired wavelength coverage must be done.

STANDARD MATERIAL USED

Two of the large type single cell flashlight batteries furnish current for the filament of the type 30 tube while the 12 volts of B battery are obtained from four double cell pencil flashlight batteries.

Referring to the list of parts and the schematic diagram it will be seen that everything is standard material with the exception of L_2 , the interruption frequency choke coil. This coil and the position of the tap on the loop have a very definite effect on the sensitivity and satisfactory operation of the receiver. The loop tap can be easily determined experimentally. The tap is correct as given when the exact parts as listed are used. L_2 , however, is the real heart of the receiver and must be approximately correct to obtain best results. A universal type of winding of not too high resistance gives the best results. It should be about 20 millihenrys and tapped about half way, or a little less, from the inside. This is not a common type of choke coil but since this receiver has become so popular it is now carried in stock by many of the radio stores that cater to the experimenter.

L_3 is the ordinary small pie-wound choke coil of between 2 and 3 millihenrys. It is mounted by fastening one lead directly to the plate connection at the socket while the other lead is passed through a small hole in the battery partition and thence to the positive connection of the B battery.

UNUSUAL TUNING

Aside from the battery connections there is almost no wiring in the set as the leads on the various condensers connect directly to their proper terminations. The general layout and mounting of the few parts can be easily determined from the illustration.

Unless you have had experience with super-regeneration on the higher frequencies you will find the tuning somewhat unusual. Referring to the schematic diagram, C_1 is the tuning condenser and C_2 the regeneration control. You will find, however, that there is some interaction between them and at first the tuning (particularly after operating a single control superheterodyne) will seem rather tricky. You will quickly catch on to the tuning eccentricity after a little experimenting.

You are going to be surprised at the results this little receiver will produce. You will find it useful, not only for sport events but for many other purposes as well. Take it with you on

vacation or business trips. You will find that it will create tremendous interest wherever it is shown. Exploring various locations for comparative radio reception is another one of its interesting possibilities. You can quickly find out how your own location compares to others

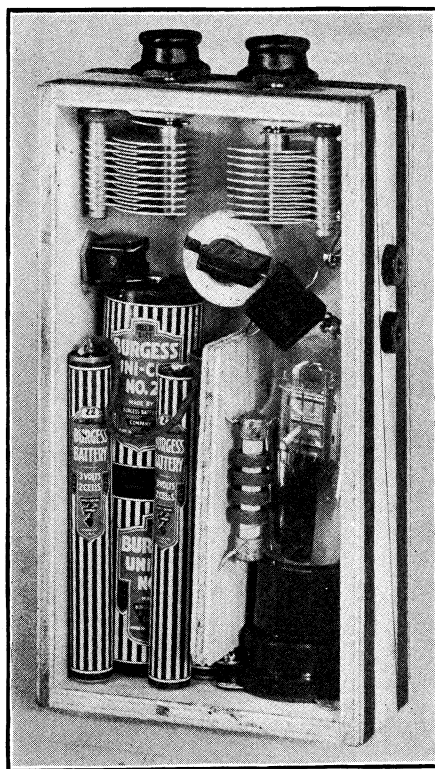

Truly small in size, the receiver is built sturdily, nevertheless. It was designed by A. J. Haynes.

for radio reception and can even sometimes locate a better position for your big antenna by exploring your roof and yard.

LIST OF PARTS

- Two 140 mmfd. midget variable condensers, Hammarlund Star (C_1 , C_2)
- One .05 mfd mica condenser (C_3)
- Two .004 mfd mica condenser (C_4 , C_5)
- One 2.1 mh choke (L_3)
- One Douglas tapped interruption frequency choke (L_2)
- One 4-prong Bakelite socket (I. C. A. No. 2480)
- Two pin jacks
- Two No. 2 Burgess flashlight batteries (1 $\frac{1}{2}$ volts each)
- Four No. 22 Burgess flashlight batteries (3 volts each)
- One 14 ohm resistor
- One type 30 tube (Sylvania)
- One spool 32 single silk covered wire (L_1)
- One S.P.S.T. toggle switch

denser of suitable value to bring the voltage at full scale to what it should be. Thus it is necessary to have available three a.c. voltages at least, 10 for the low range, 100 for the intermediate range, and 1,000 for the high range, or, if 1,000 volts are not readily calibratable, no particular correction need be applied, only the computed resistor relied on, as the difference on this range happens to be small.

ADJUSTING LOW A-C SCALE

Then there remains only the fact that the d-c scale is substantially linear, whereas the a-c low range is not, the two other a-c ranges being substantially linear. This means that, without correction, there will be some inaccuracy, but this can be corrected by putting a condenser across the two switch stops of Control 5, at position 1, about 2 mfd.

The circuit selection is made by means of a ten-position, two-circuit switch (4). The remaining controls are (3) for switching to d-c use and to "All Others" from d.c.; (2) to low resistance measurement R_L and to "All Others" for R_L ; (1) for full-scaling. It is necessary to establish the needle at full-scale deflection for high resistance R_H measurement, also for inductance L and capacity C , whereupon the upknowns interrupt the circuit and cause the needle to be deflected nearer to zero, and the nearer to zero the higher the unknown resistance or inductance, and the lower the unknown capacity. The inductances are accurate from 5 henries or so, to 1,000 henries. The resistance values are derived from a test calibration, using standards, the capacity values likewise, but the inductance is determined on the basis of inductive reactance only, so for 60 cycles there would be one henry for each 377 ohms resistance, so 3,770 ohms would be interpreted as 10 henries, etc. The ohms scale goes beyond 1 meg. The inductance measurement is made with practically no d.c. through the unknown.

LINE FREQUENCY DIFFERENCES

The line voltage may be a.c. or d.c., 90-135 volts. The reactive calibrations will apply strictly only if the same line frequency is used as was the basis of the calibration, although under the special conditions 50 cycles will do even if the calibration was for 60 cycles, with small error, though 25 and 40 cycles would surely require a special calibration, or bypass capacities (the two experimental ones) selected on the basis of 25 or 40 cycle test, applied to the calibrations made for 60 cycles. There are commercially available meters with the 60 cycle calibration and directions for 25, 40 and 50 cycle adjustment for the same scales.

THE SETTINGS OF CONTROL NO. 4

An examination of the circuit on the basis of each individual switch position will now be made.

Position 1. This is the low voltage range, 0-10, and for a 0-1 milliammeter requires a total of 10,000 ohms load resistance. The meter used had a resistance of 50 ohms, but this may be disregarded, as too small compared to 10,000

ohms and to the accuracy of the instrument, to be ratable. For d-c use the switch shown as Control No. 4 is put at the "D.C." position, and for a.c. is put at the position marked "All Others."

Position 2. This is the 0-100-volt range, and requires a resistance of 100,000 ohms, the same directions applying to Control No. 4 as previously stated.

Position 3. This is the high-voltage range, 0-1,000 volts, and Control No. 4 is worked as previously. The load resistor is 1 meg.

Position 4. This is the low-range for direct currents, 0-10 milliamperes. The meter resistance is 50 ohms, and the shunts for current range increase are determined by deciding how much the multiplication is to be (here it is ten), and dividing the meter resistance by a number one less than the multiplier. So $50 \div 9 = 5.5$ ohms.

THE A-C CURRENT RANGE

Position 5. This is the d-c current range, 0-100 ma, and the shunt resistance for the 50 ohm meter is .5 ohm, as for current multiplication of 100 or more the shunt is accurately enough determined by dividing the meter resistance by the multiplication factor ($50 \div 100 = .5$).

Position 6. This is the high-current range and requires wire that is thick enough to carry the maximum current of one ampere without overheating or changing its resistance of .05 ohm.

Position 7. Here the 10 volt range is picked up and also a 10 ohm resistor is put across the input terminals, causing the current flowing in the unknown circuit to be proportionate to the voltage drop across this resistance. One ampere is very useful as the range, so series heater currents of .3, .4, etc., ampere may be measured, as well as all other values within the limits 0-1 ampere. This is an allowable way of meeting the difficulty of measuring a-c current with any accuracy, the theoretical objection being that the resistance put in series with the unknown reduces the current in the unknown, but by keeping the resistance low, the inaccuracy is kept small.

Position 8. This picks up anew the 10-range, the repetition being merely to facilitate panel notation of another service, that of decibel measurement. For connection to the voice coil of an output transformer this low range is particularly suitable, the usefulness being applicable also to higher impedance sources, up to 1,000 ohms.

Position 9. High resistance, capacity and inductance are measured, by introducing series load resistance in the rectifier tube circuit, closing the input posts by touching the free ends of tipped test leads, adjusting the rheostat for full-scale deflection (Control No. 2), releasing the short and interposing the unknown between the tipped terminals. Control No. 1 is automatically "on" when the rheostat is effective, because the switch is on the rheostat.

Position 10. Low resistance is measured by the meter shunting method. This requires also
(Continued on following page)

(Continued from preceding page)

that the full-scale deflection current be established. Control No. 2 is again the adjuster, and Control No. 1 is automatically closed.

NEGATIVE FACTS

There are certain conditions that are not true and that should be appreciated, lest one's expectations carry one afield. Control No. 1 is not the on-off switch for the line voltage supply to the heater. With the line plug in the wall socket the heater remains heated, but without line connected to the diode proper, until Control No. 1 is switched on. The reason is that the heater must be fed for a-c measurements, and there is no object in turning off the heater supply and waiting for the tube to warm up for an a-c measurement during work that includes all types of measurements. Also, for independent on-off control of the line another panel control would be necessary.

It is not true that a.c. can be measured only where the line supply is a.c. Although the circumstance is hardly likely to arise, if the line supply is d.c., and a.c. is obtained in some special converter, the a.c. may be measured when d.c. feeds the tube heater.

The resistance measurement does not depend on the type of line voltage, but may be made whether that supply is d.c. or a.c. and likewise is independent of frequency of the line, if a.c. constitutes the supply. However, on d-c line service, no inductance or capacity measurement can be made.

Some incidental facts should be set forth as to ranges and connections. The low resistance range may be considered from one ohm to 500 ohms, for the meter-shunting method (Position 10) and for the high resistance range from (Position 9) from 0 to more than 1 meg.

When a-c or other reactive measurements are made from same line source as feeds the tube in this instrument, directly or even through a transformer, little or no reading may result, on the low a voltage range, if the plug is in the socket one way, and the correct reading if it is in the other way.

DETERMINATION OF DECIBELS

The bel notation (one bel = 10 decibels) is based on a ratio of powers. Therefore if one power is to be compared to another a ratio is established, but instead of being maintained on a percentage basis, which represents equal gradations for equal differences, it is based on a ratio that in general represents the response reaction of the human ear. This response is according to the logarithm of the powers, and the bel is a logarithmic ratio, so for sound work, or audio channels anywhere, the bel notation is very valuable.

However, the bel, like the farad, represents a quantity too large for ready application to everyday uses, and so we select instead one-tenth bel, called decibel. The formula follows:

$$\text{db} = 10 \log_{10} \frac{P_2}{P_1}$$

This is read as follows: dee-bee equal ten times the logarithm to the base ten, of P-two divided by P-one. It is understood P_2 is the

Simple to Extend Calibrated DB Range

It is intended that there be a single range calibrated in decibels, based on the 0-10-volt a-c range of the multi-purpose instrument described in the text. This range covers a total of 20 db, so the calibration covers 0 to plus 10 and 0 to minus 10 db. Note that the total change is 20 db.

However, these gains and losses, representing voltage ratios, are based on a voltage scale that is itself increased by two decimal multiples for higher voltage readings, and the calibrated db range may be increased, also, although by the addition of 20 for each voltage multiplication of 10. To be specific, the first db range equals 0 to 10 db up and down. The second a-c range is 0-100 in volts, and therefore if 20 is added to any calibrated db reading, when the switch is turned to the 0-100-volt range and a-c applied to the unknown terminals, any db reading on the meter scale is increased by 20. For the next a-c range, 0-1,000 volts, the factor of addition is 40.

Even if minus quantities arise in the readings on these two extra ranges, the 20 or 40 quantity is added just the same, e.g., for a reading of minus 5, for the 0-100 volt range, the reading is interpreted as plus 20 minus 5, or up 15 db. For the 1,000-volt range, if the reading is minus 7, since 40 is to be added, the reading equals plus 33 db. The extremes therefore for the two extensions are plus 10 to plus 30 db and plus 30 to plus 50 db, or a total change for all three of minus 10 to plus 50, equals 60. For any one range therefore the complete change is a total of 20 db, hence for three ranges it is 60.

larger of the two powers, to avoid negative logarithms, and that the experimenter or serviceman naturally knows whether he is increasing or decreasing the power, hence can ascribe the proper sign to the answer.

When the decibel power notation is used, full appreciation must be given of the fact that the load conditions are required to be equal at input and output and unchanged when the power condition is increased or decreased, in other words, a constant impedance is deemed to be maintained.

If, instead of power comparisons, voltage comparisons are made, then the formula is:

$$\text{db} = 20 \log_{10} \frac{E_2}{E_1}$$

For any power ratio, based on the voltage ratio, treat as if a voltage ratio, and divide the decibel meter reading by two.

Bearing in mind that considerations of current are ignored, and therefore the drain by the test instrument must be very small compared to the current through the voltage source being measured, if a certain zero level is accepted, the voltage thus ascribed is divided into the full-scale voltages, here 10, and yields the voltage ratio. For this ratio there is a given decibel gain, and ascribed to the position otherwise 10 for voltages only. Then lower voltages, between 10 and the zero level, are selected, and the process repeated. Gains are represented in this region. In the loss region the zero level voltage is divided by the lesser voltages, the ratios established, and the equivalent decibel losses ascribed.

As the instrument on the range used does not cause much more than a total of one milliamper a.c. to be taken from the measured source, voice coils and other relatively low impedances where currents are high, are not disturbed by the measurement.

Using the 3.2 volt zero reference level, the equivalent decibels for voltage readings are:

<i>E</i>	<i>DB</i>	<i>E</i>	<i>DB</i>
10	+10	3.2	0
9	+ 9	2.8	- 1
8	+ 8	2.45	- 2
7	+ 7	2.2	- 3
6.2	+ 6	2.0	- 4
5.6	+ 5	1.77	- 5
4.9	+ 4	1.57	- 6
4.4	+ 3	1.4	- 7
3.85	+ 2	1.25	- 8
3.45	+ 1	1.15	- 9
3.2	0	1.0	-10

The curve herewith reveals the equivalent decibels up and down for voltage ratios arising from shifts from 3.2-v. zero level, and is applicable to any 0-10 volt a-c meter of negligible draw, or to the scale up to 10, where full-scale is higher, say 15.

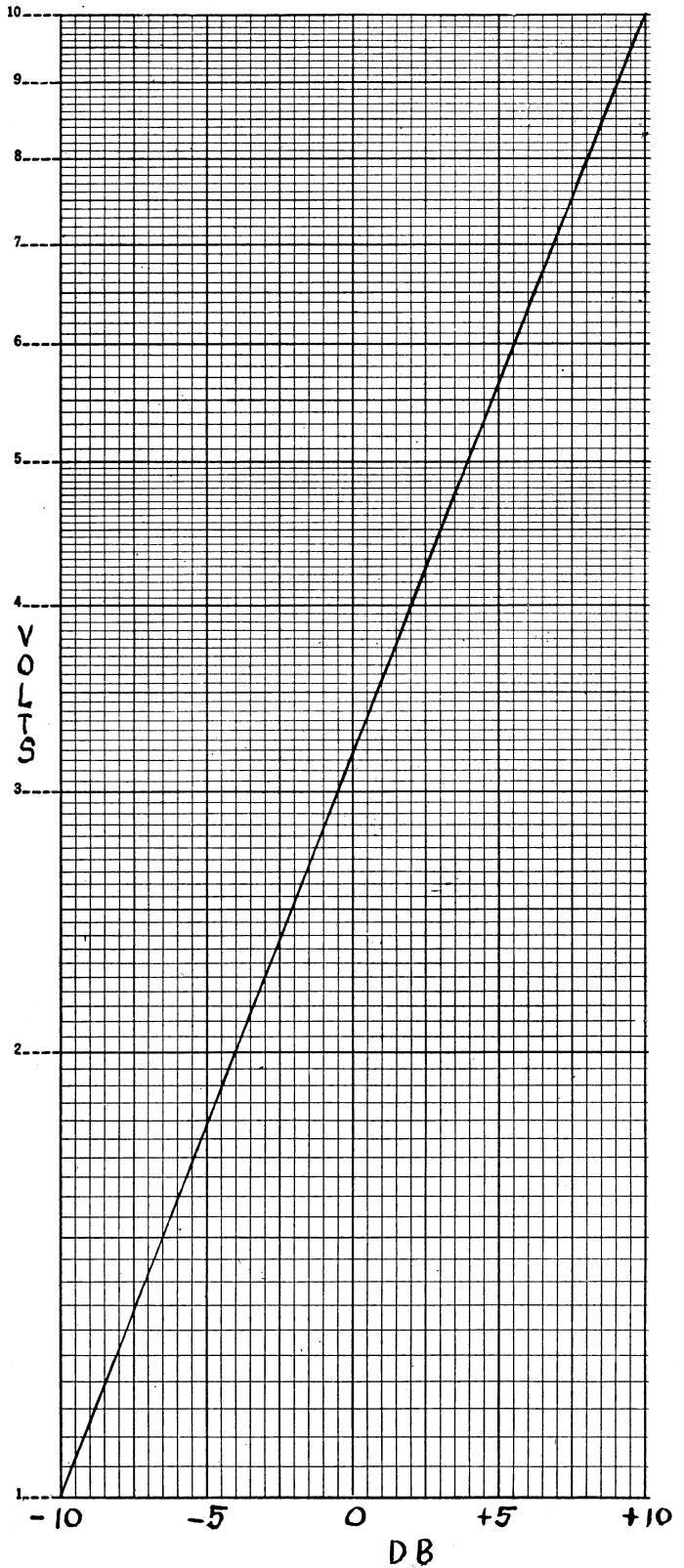

"Faultless" Oscilloscope Makes a Hit

IN last month's issue we printed a circuit diagram of what we called the "Faultless" oscilloscope. This instrument could be built up around either the 2" or the 1" cathode ray tube. It was not our design but that of a manufacturer with quite a reputation in oscilloscopy. Unfortunately the circuit he sent out had two drafting errors in it, one of which made it inoperative and the other would mar results considerably even if the first error were remedied. So we had our draftsman redraw it our way, which avoids a mixed-up appearance of a rather complicated diagram, and also of course correcting the two mistakes. We offered to send a list of parts to all interested.

That offer became onerous to fulfill. Because there was such a large demand for the list of parts, and also because we believe many who were interested in that list didn't take the trouble to write in for it, we are printing it this month.

Incidentally, some of the more industrious readers got busy right away building the oscilloscope, and the reports coming in are so enthusiastic that perhaps this fact, that experimenters and servicemen can make a go of the circuit without trouble, will induce others to build it. Typical of the results letters is one from George A. Sudheimer, of Pacific Radio Service, P.O. Box 703, Weed, Calif. He wrote:

"In the October issue of your magazine you gave the circuit diagram of an oscilloscope in which could be used the new National Union 2" tube cathode ray tube. I have constructed this unit and find it very satisfactory, with either the RCA 913 or the National Union 2002."

So here is what so many have been asking for:

LIST OF PARTS

Coils

One power transformer, Thordarson T-14R32 or equal. Primary, 115 volts. Secondaries: 5 v. at 2 a.; 5 v. at 2a., c.t.; 6.3 v. at .6 a.; 2.5 v. at 2 a.; 6.3 v. at 6 a., 350-0-350. D.c. is 300 v. at 15 ma.

One filter choke, Thordarson T-74C30 or equal; 42 henries, at 15 ma; d.c. resistance 2,100 ohms.

Condensers

Two 4 mfd. electrolytics at 400 v.
Five .05 mfd. at 400 v.
One .5 mfd. at 200 v.
One .5 mfd. at 600 v.
Two 1 mfd. at 400 v.
One .2 mfd.

One .04 mfd.
One .01 mfd.
One .0025 mfd.
One .0006 mfd.
One .0002 mfd.

Resistors

One 200,000 ohm potentiometer, with switch
One 500,000 ohm potentiometer
Four 4 meg. potentiometers
One 15,000 ohm potentiometer
One 1 meg. potentiometer
One 25,000 ohm, 10 watts
One 10,000 ohm, 2 watts

One 220 ohm, $\frac{1}{2}$ watt
Five 1 meg., $\frac{1}{2}$ watt
Three 100,000 ohm
One 250,000 ohm, $\frac{1}{2}$ watt
One 750,000 ohm, $\frac{1}{2}$ watt
Two 1,000 ohm, $\frac{1}{2}$ watt

Sockets

Two UX (four hole)
Two six-hole

One UY (five hole)
One octal

Tubes

One 2" or 1" cathode-ray tube
Two 80 tubes

Two 6C6 tubes
One 885 tube

Other Requirements

Five binding posts
One single circuit, seven position switch
One two circuit, two position switch

One single circuit, on-off switch
Twelve bar handles

Columbia's Television Transmitter Gets First Power Tests

THE Columbia Broadcasting System's new television transmitter, construction of which required the work of fifty technicians for more than nine months, is being given its first power tests at a Camden, N. J., manufacturing plant and probably will be ready for delivery to New York shortly after the first of next year.

When all "bugs" have been eliminated the transmitter is to be shipped to New York for installation on the 73rd and 74th floors of the Chrysler Building. There it will provide television programs from the Grand Central Station studios nearby. The emissions may be picked up within a radius of approximately 40 miles over a total area of about 4,800 square miles of thickly populated territory.

Columbia's new transmitter really consists of two complete units almost identical in construction. One of these will be used to transmit high fidelity sound while the other produces pictures exactly synchronized with that sound.

SMALL DIFFERENCE BETWEEN TWO

Only a slight difference in design is needed to perform these separate functions, although the sound transmission will cover a frequency range of up to 10,000 cycles while the wave band needed to reproduce high frequency 441 line interlaced pictures is 2,500,000 cycles.

Twenty-four water-cooled tubes, ranging in length from ten inches to around four feet, have been especially designed for use in the two transmitters. Each of the transmitters has a 7,500 watt output with a 30,000 watt peak modulation. Because tremendous heat will be generated by the 400,000 watts of power consumed in producing this output, a complete air conditioning unit has been built to cool the 120 gallons of water per minute used to reduce the temperature of the vacuum tubes and other parts of the equipment. In addition 1,000 gallons of oil are needed to cool the ten gigantic transformers.

The main power units, consisting of the transformers and motor generators, will be housed in fireproof vaults on the 73rd floor of the Chrysler Building, while the transmitter itself is to be housed on the 74th floor.

CHROME AND SATIN STEEL FINISH

The transmitter will be connected with a power distribution panel 16 feet long by 7 feet high and a transmitter panel 46 feet long, the right hand half of which will be devoted to sound and the left hand to sight. There is to be a control desk or automatic watchman in the center of the transmitter panel from which operation of the whole set can be checked. The entire ensemble will be finished in chrome and satin steel.

Every safety precaution has been taken. The steel structure of the Chrysler Building's floors is being strengthened to bear the additional

weight. The control panel is equipped with lights which indicate failure of operation at any part of the equipment. A second series of controls and lamps is installed back of this panel so that in an emergency the transmitter can be controlled from there. Interlocking automatic circuits have been arranged so that power will be cut off and signal lamps lighted the instant anyone opens a door leading to the high tension wiring.

The 74th floor also contains a room where all input circuits from the adjacent Grand Central Station studios come in and another where power from the public utility company is introduced.

STUDIO OVER GRAND CENTRAL

When all of this equipment is ready for installation, it will be necessary to construct special rigging to lift it from the 71st floor, where elevator service ends, to the floors above.

The Grand Central studio across the street from the Chrysler Building was chosen by Columbia because it is easily accessible, centrally located and near the transmitter. This will make program production easier as well as assure power transmission with the least possible loss or distortion. Incidentally, this problem of power transmission is further simplified by the fact that the antenna for the new station is located just under the stainless steel needle of the building only 90 feet from the transmitter.

The studio space is directly over the main waiting room of the station and is 40 feet high, 230 feet long and 60 feet wide. In addition to dressing rooms, laboratories, etc., there is room for two large studios but only one is to be constructed immediately.

32 CIRCUITS IN CABLE

Television cameras, which also are being given final tests at Camden, look much like those used on motion picture stages. They are mounted on counterweighted "dollies" so they can be moved about easily and raised and lowered at will. Each is connected to its control equipment by a flexible cable one and a half inch thick which contains a total of 32 circuits, four of which are coaxial.

Experiments now are going on in Camden to determine the type of antenna best suited for the transmitter and also for the Chrysler pinnacle around which it is to be constructed. A complete "electrical reproduction" of the top floors of the skyscraper has been constructed on a baseball field used by employees of the manufacturing plant and different kinds of antennas are being built and tried out on this structure under conditions almost identical with those on the tower itself. The reproduction is built of wood and steel and covered with heavy wire netting. It looks much like an oil well derrick.



TELEVISION PICKUP IS OUTDO

EXPANDING the scope of its experimental television, the National Broadcasting Company will inaugurate outdoor pick-ups this month for the first time in America with an RCA mobile television station, Lenox R. Lohr, NBC president, announced at Radio City.

The outdoor experimentation, said Mr. Lohr, will be another forward step in the television field tests conducted in cooperation with the Radio Corporation of America, NBC's parent company. Immediately after the delivery of the new station, NBC engineers will begin an intensive schedule of television outdoor scenes and current events. Football games and other sports, parades and news events are listed in the outdoor schedule. All of the work, however, will be strictly experimental, with a view

VIDEO TRANSMITTER

PICTURE AND SOUND PICKUP

TRANSMISSION BY MICRO WAVE TO EMPIRE STATE BUILDING, THENCE BROADCAST.

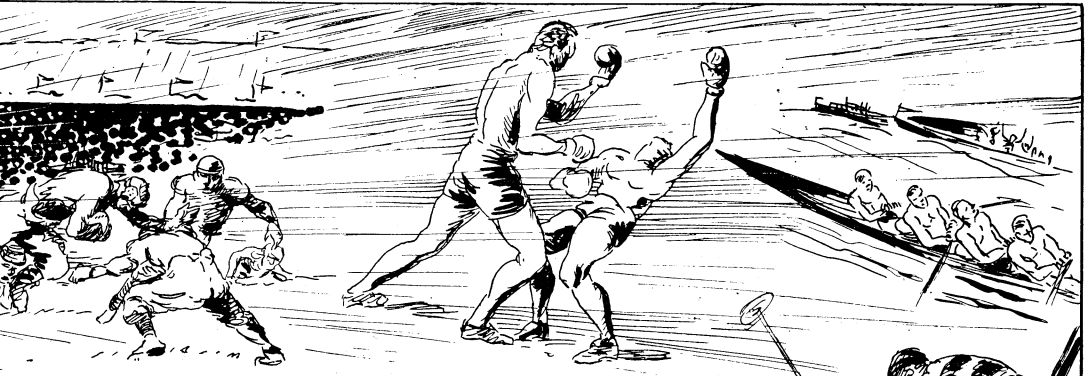

HANSON'S COMMENT SOUND MOVIE DOORS

to improving the equipment and methods of RCA television.

HANSON'S COMMENT

"The public," said O. B. Hanson, NBC chief the mobile station, "will expect television to bring distant current events into the home.

"In addition to studio productions, it wants such things as Presidential inauguration ceremonies, political conventions, football and baseball games, boxing matches, fashion parades and all the shows we now class as special events. Through radio it has heard descriptions of all these; sometimes the sounds of the events themselves. What the American public will eventually demand is that television bring faithful

(Continued on following page)

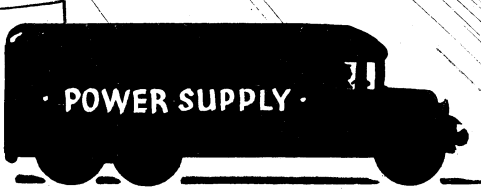
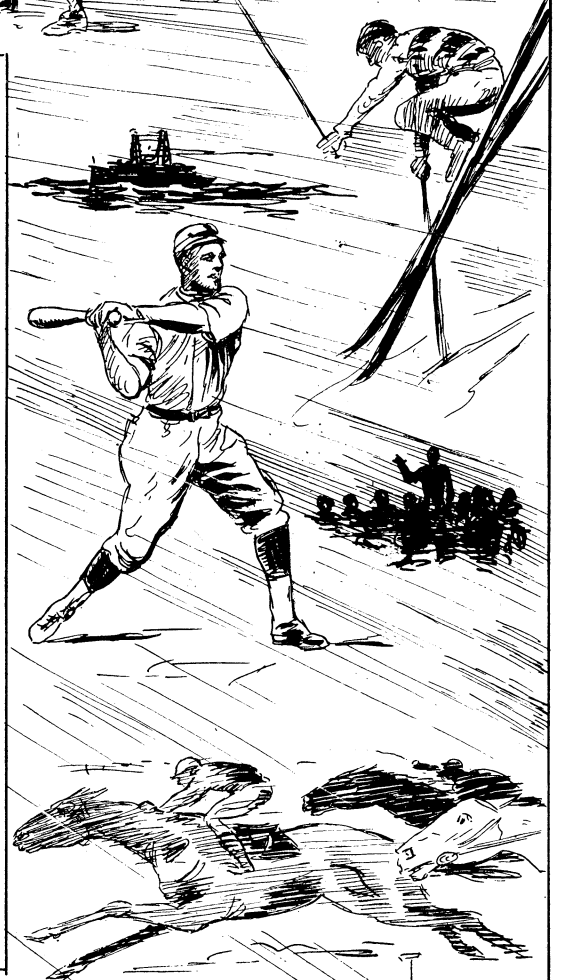

BARBELL

(Continued from preceding page)

sound and image reproductions of all into the living room.

"This new mobile unit will enable us to make a start toward supplying that demand. In taking television outdoors we expect to learn much about the sensitivity of our instruments, the use of different types of lenses, filters and shades, the spectral characteristics of sunlight, the effect of reflected light, spheres of action and so on.

GROUP TO BE TRAINED

"Our immediate purpose is to train a group of men in handling the problems of special events. We shall have need of all the practical experience we can accumulate between now and the day when television becomes a daily public service. When that will be, even in the limited area of New York City, it would be foolhardy to guess.

"All of our outdoor work will be strictly experimental. After eight years of continuous research and experiment in cooperation with the engineering staff of the Radio Corporation of America, we feel that we are ready to attack the intricate problems presented by field television. The many contributions we have made to the new art, both in matters of practice and apparatus, will be of considerable help. We are steadily improving the quality of our images; sometimes we feel that our progress is rapid. But we realize that it will be a long time before we can deliver pictures of outdoor events that will meet the home entertainment requirements."

TWO MAIN VANS

The new mobile television station will consist of two specially constructed motor vans, each about the size of a large bus. Apparatus for picture and sound pick-up will be installed in one, and a video transmitter, operating on a frequency of 177,000 kc (1.694m) in the other. In the metropolitan area, where many tall buildings make high frequency transmission difficult, the unit's workable range will be about 25 miles. Ten engineers will be required to operate the two television units. In the experimental field work NBC's present mobile sound transmitter will be included in the station.

Both picture and sound will be relayed by micro-wave to the NBC television transmitter in the Empire State Building. There the programs will be broadcast to the 100 receivers NBC has placed in the homes of trained observers throughout the metropolitan area. The television system to be used will be entirely electric, based on the cathode ray tube developed by RCA Manufacturing Company.

FULLY EQUIPPED

The van mounting the video, or picture, apparatus will be the mobile equivalent of a television studio control room. It will be fitted with television and broadcasting equipment similar to that now in use at Radio City. This will include two cameras, video amplifiers,

blanking and deflector amplifiers, synchronizing generators and rectifiers for supplying the Iconoscope beam voltages.

The principal sound apparatus will be microphones, microphone amplifiers and sound mixing panels. All the equipment will be mounted on racks extending down the center of the van, affording easy access to any part for repairs, and the alterations which will arise from the outdoor experimentation.

Directly in front of the operating engineers in the semi-darkened control room will be two monitoring Kinescopes. One will show the scene actually being transmitted; the other will show the scene picked up by the second Iconoscope camera preparatory to transmission. Sound will be picked up by a variety of microphones, including the parabolic microphone developed in the NBC laboratories, and will be monitored by loudspeaker. An elaborate telephone cue circuit will keep the ten engineers in contact with one another.

STUDIO SERVICE DUPLICATED

The two Iconoscope cameras, to be mounted on tripods, will be technically equivalent to studio cameras, although considerably lighter in weight, focusing will be done by looking directly onto the plate of the Iconoscope, instead of through a separate set of lenses, as in the case of studio cameras. The cameras will transmit the image through several hundred feet of multiple core cable, affording a considerable radius of operations. Four operating positions will also be available on the roof of the van.

The micro-wave television transmitter will be housed in the second van, linked to the first by 500 feet of coaxial cable. Here the principal apparatus will be the radio frequency unit, generating the carrier wave for picture signals, and modulating apparatus for imposing picture signals on this carrier. The signals will be transmitted to the Empire State station's directional receiving antenna either from a single dipole antenna raised on the van's roof, or from a highly directive antenna array raised on the scene of the pickup.

SPARE POWER IN THIRD VAN

Because the transmitting equipment will generate much heat in operation, the interior of the van will be cooled by air drawn through filters at the rear of the vehicle and forced out through the front compartment. A water cooling system will be installed to maintain tubes at operating temperatures.

NBC engineers are at present designing a completely self-sufficient power unit to be used where suitable power supply for the mobile station is not available from New York's commercial service. Occupying a third motor van, this unit will be a generator driven by a gas-line motor and capable of supplying the alternating current required by both the control room apparatus and the transmitter. Power for the mobile station must be free from fluctuations which might seriously affect the operation of television apparatus.

TWO NEW KINESCOPIES INVITE EXPERIMENTATION IN TELEVISION

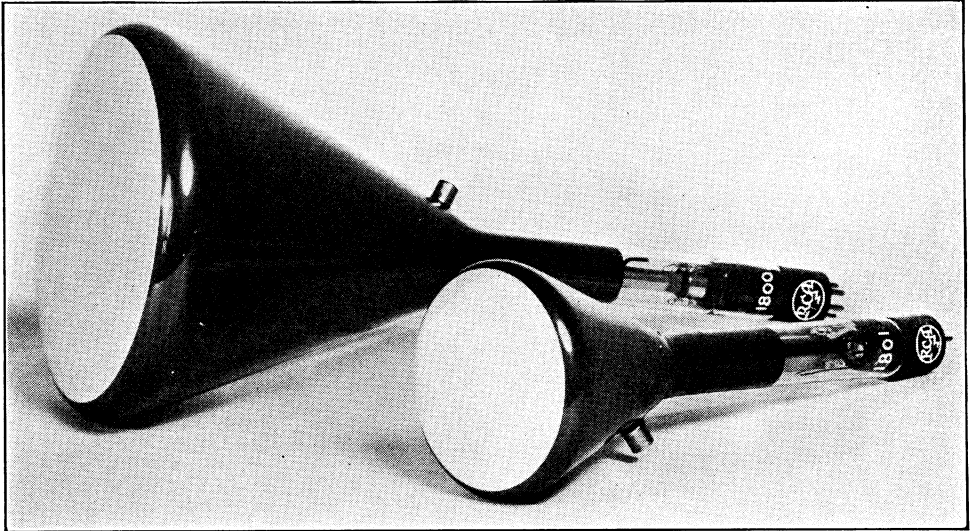

Now, for the first time, Kinescopes for the public. They have electromagnetic deflection plates.

RCA Manufacturing Company, Inc., has made available through its transmitting-tube distributors two new cathode-ray tubes intended for television reception, for the convenience of experimenters and amateurs who wish to con-

(Continued on following page)

1800 KINESCOPE

Electromagnetic-Deflection Type with 9" Medium-Persistence Screen for Television Picture Reception
(Tentative Data)

Heater Voltage (A.C. or D.C.)	2.5	Volts
Heater Current	2.1	Amperes
Fluorescent Screen:		
Material	Phosphor No. 3	
Color of Fluorescence.	Yellow	
Direct Interelectrode Capacitance:		
Grid No. 1 to all other electrodes	12 max. $\mu\mu\text{f}$	
Overall Length	21" \pm $\frac{3}{8}$ "	
Maximum Diameter.....	9 $\frac{1}{16}$ "	
Bulb	J-72	
Cap	Medium Metal	
Base	Medium 6-Pin	

Maximum Ratings and Typical Operating Conditions

High-Voltage Electrode (Anode No. 2) Voltage	7000 max. Volts
Focusing Electrode (Anode No. 1) Voltage	2000 max. Volts
Accelerating Electrode (Grid No. 2) Voltage	250 max. Volts
Control Electrode (Grid No. 1) Voltage.....	Never positive
Grid No. 1 Voltage for Current Cut-off*	-75 approx. Volts
Fluorescent-Screen Input Power/sq. cm.	10 max. Milliwatts
Typical Operation:	
Heater Voltage.....	2.5 2.5 2.5 Volts
Anode No. 2 Voltage	3000 4500 6000 Volts
Anode No. 1 Voltage (Approx.)	625 925 1250 Volts
Grid No. 2 Voltage..	200 250 250 Volts
Grid No. 1 Voltage..	Adjusted to give suitable luminous spot
Grid No. 1 Signal—Swing Voltage (Approx.)**	20 25 25 Volts

*With approximately 250 volts on Grid No. 2.
**Peak-to-peak value for optimum contrast.

(Continued from preceding page)
 struct experimental television receiving equipment. Identified as the 1800 and the 1801, these new tubes are known as Kinescopes.

The 1800 and the 1801 are of the electro-

magnetic-deflection type and employ viewing screens on which pictures appear with a yellowish hue.

The 1800 has a 9-inch screen, while the 1801 has a 5-inch screen.

**1801
 KINESCOPE**

Electromagnetic-Deflection Type With 5" Medium-Persistence Screen for Television Picture Reception

(Tentative Data)

Heater Voltage (A.C. or D.C.)	2.5	Volts
Heater Current	2.1	Amperes
Fluorescent Screen:		
Material	Phosphor No. 3	
Color of Fluorescence	Yellow	
Direct Interelectrode Capacitance:		
Grid to all other electrodes	12 max. μ mf	
Overall Length	15 3/4" \pm 3/8"	
Maximum Diameter	5 1/16"	
Bulb	J-40	
Cap	Medium Metal	
Base	Medium 5-Pin	

Maximum Ratings and Typical Operating Conditions

High-Voltage Electrode (Anode No. 2) Voltage	3000 max. Volts
Focusing Electrode (Anode No. 1) Voltage	1000 max. Volts
Control Electrode (Grid) Voltage	Never positive
Grid Voltage for Current Cut-off*	-35 approx. Volts
Fluorescent-Screen Input Power/sq. cm.	10 max. Milliwatts
Typical Operation:	
Heater Voltage	2.5 Volts
Anode No. 2 Voltage	2000 Volts
Anode No. 1 Voltage (Approx.)	325 Volts
Grid Voltage	Adjusted to give suitable luminous spot
Grid Signal-Swing Voltage (Approx.)**	15 Volts

*With approximately 500 volts on Anode No. 1 and 3000 volts on Anode No. 2.
 **Peak-to-peak value for optimum contrast.

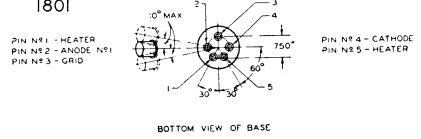
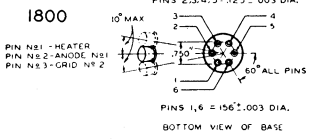
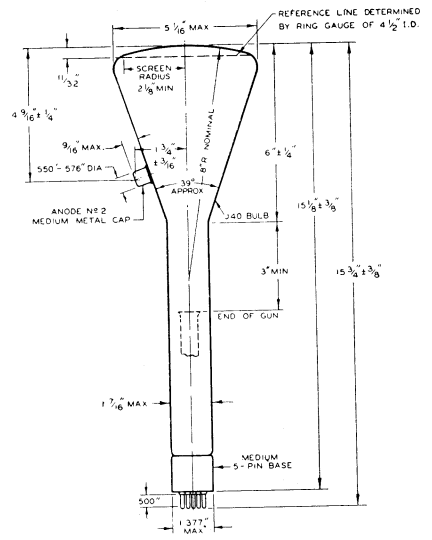
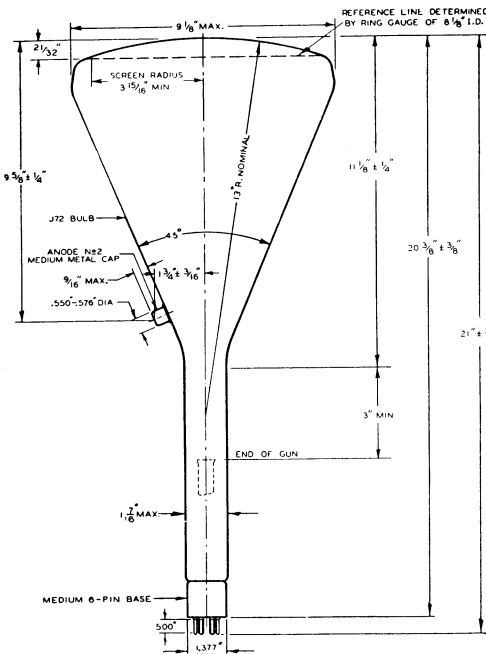

Relative sizes of the 1800 and 1801 tubes for television experimentation, with absolute dimensions and also bottom view of sockets for correlation with the textual pin identification.

BY DAVID SARNOFF:

President, Radio Corporation of America

British Television Technically Satisfactory But Public Aloof from \$200-\$500 Sets

DURING my five weeks' stay abroad, I studied the latest developments of television in Europe. While interest is shown everywhere in this new branch of the radio art, greater progress has been made in England, I found, than elsewhere in Europe.

Nevertheless, the experience to date with television in England has only served to emphasize the formidable nature of the problems which must be solved before a satisfactory service of television to the public can be rendered, and a new industry soundly established.

The question is often asked: "Is England ahead of the United States in television?" I shall try to answer this question by stating the facts as I have now observed them on both sides of the Atlantic.



DAVID SARNOFF

PATENT RIGHTS EXCHANGED

The B. B. C. (British Broadcasting Corporation) has been operating its television transmitter, located at Alexandra Palace in London, for about a year. The range of this transmitter is more than 25 miles and covers all of London and its immediate vicinity. The system employed is known abroad as the Marconi E. M. I. Television System which is fundamentally based on the R. C. A. Television System first developed in the R. C. A. Laboratories in the United States. Under an exchange of patent licenses, this British Company may use RCA patents in England and, in turn, RCA and its American licensees may use British patents in the United States.

Each side is therefore in a position to benefit from developments and improvements made by the other.

For nearly one year the B. B. C. has been broadcasting television programs to the public on a regular daily schedule of one hour in the afternoon and one hour in the evening.

Some fifteen British radio manufacturers have been offering television receiving sets to the public at prices ranging between \$200 and \$500 each. At the Olympia Radio show, which I visited while in London, all the manufacturers exhibited their latest television sets and the

public could view the actual operations of television while visiting the radio show.

FEW RECEIVERS SOLD

From a technical standpoint the results were highly satisfactory. The public filled the television booths and showed great interest. But while hundreds of thousands of ordinary broadcast receivers were sold during the show, the public bought less than 100 television receivers in total.

During one year's operation of a public television service in England, less than 2,000 receivers in all have been sold to the trade and less than 1,000 are actually in the hands of the public. There is but one television transmitter in London, and I was informed that it will probably be two years more before a second transmitter is erected in any other part of England.

The foregoing represents the present status of television in England despite the fact that geographically its problem is simple compared with the vast area to be served by a television service in the United States. Also it is to be noted that in England the costs of erecting a television station, the establishment of a special organization, and the furnishing of television programs, have been paid by the Government out of license fees paid by the public annually for the privilege of listening or seeing by radio.

PROGRAM PROBLEM SEVEREST

The range of the RCA television transmitter atop the Empire State Building, now operated by the NBC from its television studios in the RCA Building in New York City, is approximately the same as that of the B. B. C. station in London. The television receivers installed in the homes of our experts, who have been carrying on field tests during the past year, are likewise of the same order of performance as those in use in England.

The major problem of television, in both countries, is to provide a program for the home that will meet public requirements and maintain public interest.

To place television on a commercial basis in the United States it is necessary to establish a sufficient number of sending stations that must be interconnected and able to furnish a regular service at least to the population residing within the principal market areas of our country. The erection of such stations, the provision of necessary interconnecting facilities, and the establishment of a regular program service that

(Continued on following page)

Must Capture World's Action, Says Goldsmith

Residents of New Jersey will have front row seats in the "theatre of the air" when television becomes a public service, Dr. Alfred N. Goldsmith, former vice president of the Radio Corporation of America and now technical consultant to the company, told the New Jersey Press Association, in congress at Rutgers University.

Dr. Goldsmith in his talk explained that in the northern part of the state particularly, experimental field tests have shown reception conditions often as good as those met with in many parts of metropolitan New York, where the RCA transmitting station is located, in the Empire State Building.

Dr. Goldsmith traced the operation of the RCA electronic television system from pick-up to receiver image. "We may call it a 'celestial art,'" he said, "because the higher the transmitting and receiving antennas, the more nearly ideal are the conditions of operation."

The problems of programming television are not the least of its developers' worries, he said, adding: "It costs Hollywood \$400 to \$30,000 to produce a minute's worth of usable feature film for a total of 600 hours' entertainment a year. Present sound broadcasting networks render service for upwards of seventeen hours each day.

"Television must develop its own program technique. If we may summarize the ultimate characteristics of such programs in a word, it should be 'spontaneity.' Television must capture images of the world in action.

"Television networks of stations comparable to those existing in sound broadcasting must await the development of either the co-axial cable or automatic radio relay stations. Meanwhile, if public service should be inaugurated, the individual station has recourse to three classifications of program material: local talent, motion picture film, and 'road shows' of live talent traveling from studio to studio."

In the instance of the last, it was pointed out that "stock companies" would face the necessity of developing a new make-up technique, since the television camera does not "see" its images in the same values of color and tone as does the eye or motion picture camera.

Dr. Goldsmith, who has been actively interested in the development of television for more than a dozen years, said that upwards of ten million dollars, probably had been expended on its development to date, by all experimenters, and that current research appropriations might total between one and two million dollars a year.

(Continued from preceding page)

would meet public requirements and hold public interest, call for vast financial expenditures before any returns can be reasonably expected.

I firmly believe in the American system of private enterprise, rather than Government subsidy; of free radio to the home, rather than license fees paid to the Government by owners

YMCA School in New York Gives Third Electronic Course

For the third consecutive year the New York Y.M.C.A. Schools, 5 West 63rd Street, New York City, will conduct a course in electronics which will cover instruction in radio communication, broadcasting, radio servicing, sound picture servicing, television, electronic systems and industrial electronics.

Students will be trained for positions in the radio field as junior and laboratory assistants, assistant research engineers and other positions. The length of the course is one year day or two years evening. The course of study in the first semester includes radio physics, electrical theory, sound picture servicing, radio servicing and radio code (optional). In the second semester the following subjects are studied: electronic theory, electron tube circuits, electronic systems and industrial applications and television.

The second term of the evening course in electronics, which is now starting, is open to those who have completed the first semester and to other properly qualified students. Among some of the laboratory projects to be worked out in this advanced course are: construction of a vacuum tube voltmeter, tube oscillator, audio frequency phototube amplifier, phototube control of a thyatron tube with several industrial applications, an ultra-high frequency oscillator for heat production (biology and medicine), and other interesting experiments dealing with the electron tube in industry.

Cornell-Dubilier Operates 11 Buildings to Capacity

Heralding the 1937-38 radio parts season with a still greater line is the Cornell-Dubilier Electric Corporation, the world's largest condenser manufacturers. On all of the Cornell-Dubilier line of latest type condensers demands have necessitated an increased production schedule. At present eleven buildings covering thirty-three acres are operating at full capacity.

A new complete listing of the various types of radio capacitors now in demand has just been released. Known as Catalog 151A, this booklet may be obtained by writing to the Cornell-Dubilier Electric Corporation, South Plainfield, N. J.

Besides its enormous business with set manufacturers and other commercial users, C-D does a vast jobbers business.

of receiving sets. I have no doubt that, in due time, we shall find practical answers to the practical problems that now beset the difficult road of the pioneer in television. The road calls for faith and perseverance as well as ingenuity and enterprise, but it is a road that holds great promise for the public, for artists and performers, and for the radio industry.

Beams Greatly Aid DX

Antennas Direct Transmissions and Concentrate Power

A LOT of electricity has been pumped into the ether since radio waves were first compared to the circular ripples which result when one tosses a pebble into a pool. Today engineers are able to control those waves for the edification and entertainment of distant listeners-in.

Consider W2XE, Columbia's international short wave station in New York, for example. Not so long ago this transmitter could be heard in Europe and South America only by persistent DX'ers working with expensive receivers under perfect weather conditions.

Then came an increase in power plus a number of latest type directional antennas and W2XE's rebroadcasts of Columbia network programs boom into England almost as loudly as do local and Continental stations, according to reports from British listeners, while it can be tuned in without difficulty along the entire length of both coasts of South America.

HOW ANTENNAS ARE BUILT

The power increase helped but the directional antennas make it possible for W2XE to radiate its beams in the form of long ellipses instead of concentric circles and to change the radiation angle of the beams (in relation to the surface of the earth) to "bounce" the beams off the Heaviside layer of ionized air in the stratosphere.

Directional antennas are built in the form of huge V's which act in much the same fashion as if one constructed a V of planks in that pool referred to above and dropped a pebble in the angle of this obstruction. The ripples generated would then tend to extend fanwise from the open end of the V rather than spread in quickly-dissipated circles.

For its European transmissions W2XE uses a large, horizontal, two-element antenna which can be operated on a number of different wavelengths. Although the details of its design are extremely complicated it looks relatively simple, consisting mainly of two wires several wavelengths long set on three tall poles so that the open end of the V is pointed toward Europe. The carefully calculated angle of this opening is such that the station's power is directed mainly toward London and the great Continental capitals where the listening audience is concentrated.

MORE EFFICIENT TYPE

The South American antennas are of a different and more highly efficient type known as the multiple-element inverted V. From the top of a tall pole in the center a number of parallel

wires are stretched to shorter poles which form the ends of the V pointing southward. They suffer from the disadvantage of being operable only on one or at most two closely related wavelengths, but the wide angle necessary to concentrate the station's power in two lines which would hit such widely separated points as Lima, Peru, on the West Coast of the continent, and Buenos Aires, Argentina, on the East Coast, several thousands of miles away, made the inverted V type necessary.

One of these, consisting of four wire elements several wavelengths long, operates on either 11.83 or 15.27 mc, while another two-element antenna can use either 21.52 or 17.76 mc. The efficiency of all these structures is determined by the conductivity of the soil beneath them, the height, length, spacing and number of elements and the phasing of the electrical current in each element.

The next thing to be considered is the angle in relation to the earth's surface at which these short waves are radiated in order to get distance. Years of experimentation have proved that such waves are reflected by the Heaviside layer (or ionosphere) much as a beam of light might be reflected downward is directed at a huge mirror hanging in the sky.

RELATION OF ANGLE AND DISTANCE

Thus, theoretically, the lower the angle at which the beams are radiated the farther they will travel before hitting the ionosphere and the farther will be the distance at which they are reflected back to earth. This is one of the reasons why W2XE is seldom heard by DX'ers in the New York area. Its low angle waves do not strike earth for the first time until they reach distant points (such as the tip of Florida). The other reason is that, while broadcasting stations have a strong ground wave which allows them to be picked up nearby, this wave is attenuated so rapidly at high frequencies that it is of no value for this purpose.

The ionosphere's height from the surface of the earth varies from 50 to 150 miles depending on the season of the year and the sun spot cycle. It is not a perfect sphere but has irregularities as to position and height. In spite of these vagaries radio engineers now have a pretty good idea of where the layer will be located at any given time and can manipulate their angle of radiation accordingly to obtain the best results.

Listeners-in often write to Columbia to inquire why they can sometimes hear W2XE in Europe when it is using the South American

(Continued on following page)

TOOTER FINDS STATIONS FAST

By Sidney S. Fleischman

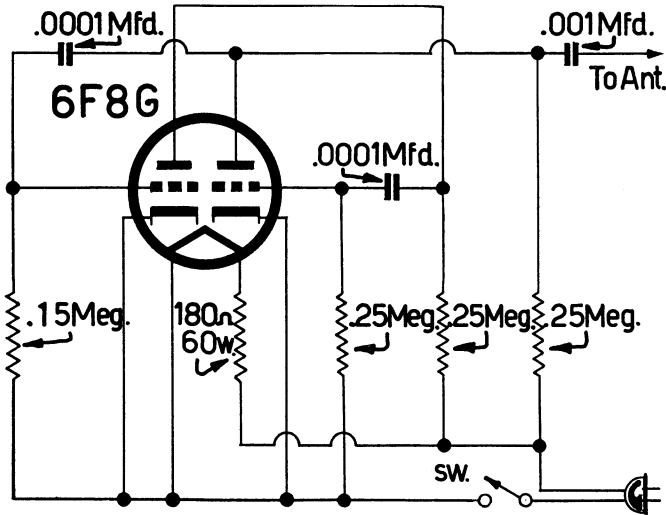

Two tubes in one envelope may be used for building the tooter, as shown at left, or two separate envelopes may be used, as preferred. Data on correction of the line limiting resistor for separate-envelope tubes are contained in the text.

ALTHOUGH a few of the very latest receivers of regular commercial production have bandspread for the popular foreign short-wave bands, so that you turn the dial considerably before you change the frequency of reception very much, most receivers now in homes suffer from crowding of practically all short waves. For each short-wave switch position there is maximum of crowding around the low capacity end of the tuning condenser. It is therefore all too easy to pass over a station.

A solution for this difficulty, and one embodied in many communication type receivers, which are instruments especially engineered with excellence of short-wave reception as the goal, is to have a beat frequency oscillator. Ordinarily this would be a feeble oscillator weakly coupled to the second detector of a superheterodyne, and would beat with the true intermediate frequency, the one generated by the mixer.

With an adjustable control of the frequency
(Continued from preceding page)

(Continued from preceding page)

antennas or vice versa. The explanation is that such antennas are by no means 100 per cent efficient. The horizontal type has a tendency to radiate some power from the tip of its V, and often can be picked up in Los Angeles, for example, while transmitting to England.

BETTER DISCRIMINATION

The inverted antennas are so much more efficient that while the station's signal is strong on the coasts of South America where the population is concentrated, it is almost inaudible in the direction of Europe. But even with these, 500 watts may be radiated toward England at the same time that 10 kilowatts is being

pumped across the Equator. This power, under ideal conditions, can be picked up across the Atlantic by a good set.

The experiments now taking place at W2XE are observed regularly by the International Broadcasting Union in Brussels, Belgium, according to A. B. Chamberlain, CBS chief engineer, while professional observations of the strength and variations of the station's signal are being made constantly by the Union and the British Broadcasting Corporation. These data will be used at the Cairo Tele-Communications Conference in 1938 in determining the feasibility of operating a number of stations on the same or adjacent frequencies simultaneously; in allocating such frequencies and making recommendations for operation of short wave broadcast transmitters throughout the world.

of this small oscillator, the audio frequency of the beat may be adjusted to any value that is most acceptable to the ear, by making a small difference exist between the two intermediate frequencies. Or for reception of a particular type of code transmission whereby the carrier is

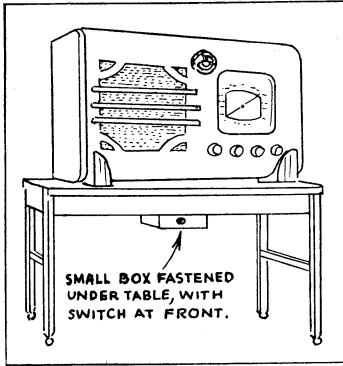

Tooter located under the table on which a small set is placed. The handy switch is at front to turn the tooter on and off. The tooter's output is permanently connected to the antenna post of the receiver.

taken off and put back on the air in a way to represent the code used in such telegraphic communication, the beat oscillator permits reception of such emissions, and adjustment of the resultant audio frequency to the one to which the 'phones or other reproducing device are most sensitive. This type of reception, popular with amateurs, is known as c.w. and the initials represent "continuous waves." Actually the waves are discontinued, but the point is they have no modulation impressed on them, the presence of a note, and its duration, or the absence of a note, with consequent blank or "space," instead of "mark," being the distinguishing characteristic.

Perhaps not all has been gotten out of the beat principle as a helpful adjunct to reception. It is true that for a superheterodyne an i-f oscillator provides a satisfactory method of producing a beat, but there are difficulties in the way of using this as an adjunct to an existing superheterodyne, e.g., establishing the correct coupling, frequency, supply, etc. Or, if there are to be oscillations at the station-frequency level, the frequencies of oscillation would have to be changed for every different frequency tuned in, or an inadequate mitigation of this nuisance introduced by resort to harmonics.

It is therefore proposed that a fixed-frequency oscillator that is abnormally rich in harmonics be coupled to the antenna and used as a single-frequency oscillator to produce whole-number multiples, all of which will mix with any incoming station frequency, and produce a beat. The note will not be exactly the same for all stations, but always there will be a note, and that is entirely sufficient.

To make this possible the fixed-frequency

oscillator would have to generate a low frequency, in the audio region, and yet produce harmonics up to the 5,000th. It seems inconceivable that there is or can be such an oscillator. Remember, we are striving for a device attachable to the antenna post, and that does not require any band switching to make the notes audible.

We find the solution in the multivibrator, which is a two-tube resistance-coupled amplifier, output of the second tube coupled to input of the first tube, the phases being right for oscillations. And that there is oscillation aplenty may be taken for granted. Anyone who has experimented with multivibrators is completely convinced of this.

To set up the circuit, either a combination of two tubes in one envelope may be used, as in the diagram, or two separate tubes. If two tubes of the .3 ampere type are used, such as 37, 76, 6C5, 6J5G, 6J5, etc., are used, then the line cord limiting resistor need be 350 ohms, 30 watts. This overcomes the objection to 60 watts (see diagram).

NO RECTIFIER NEEDED

Fortunately, there is no need for a rectifier, for the modulation of the line comes in handy, when the device is used on 90-130 volts a. c., but usefulness is in no sense destroyed if the line is of the same voltage d. c., but then an incoming station must be depended on to help create the note, whereas with line hum a little response is obtainable even if there is no station, although the presence of a station augments the note's strength considerably.

(Continued on following page)

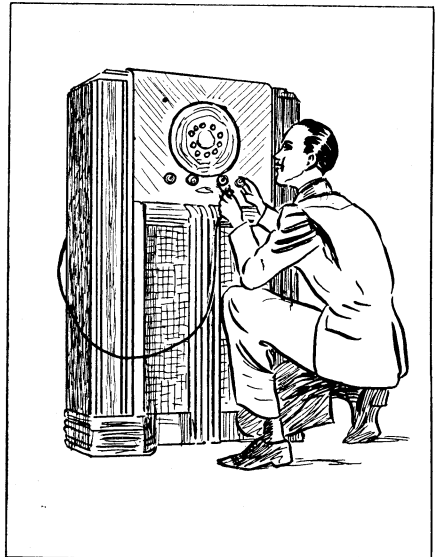

For use with a console type receiver the tooter may be located within the console with switch at end of cord brought to the operator's hand only when the tooter is in use.

BUY A 'SCOPE and Scratch Your Head!

*Must Mix Knowledge with
the Operation to Get Any
Value at All Out of Instrument*

By Donald V. Osgood

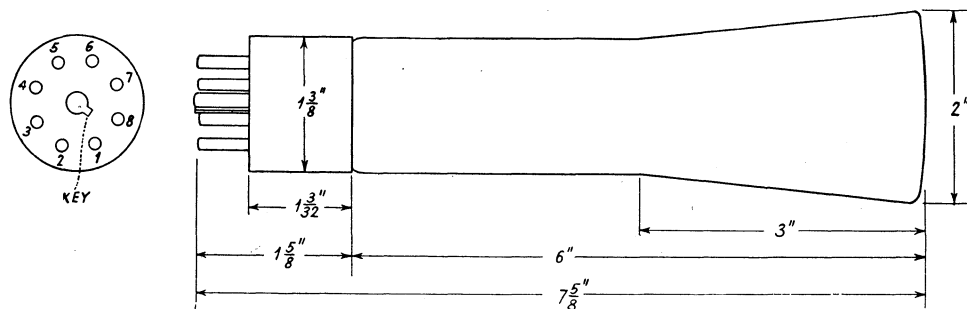

Dimensions and other data for the new 2-inch oscilloscope tube. This tube may replace the 1-inch tube in any 'scope, provided room is made for the larger bulb, with circuit changes. Bottom socket view shows 1 = Anode No. 2 and two return deflecting plates; 2 = heater and cathode; 3 = anode No. 1; 4 = one input anode; 5 = control grid; 6 = other input anode; 7 = heater; 8 = no connection. Input anodes are interchangeable.

THE general rule about a person who buys an oscilloscope is that, after he gets it, he doesn't quite know what to do with it. This does not mean at all that the device is lacking in great value, but rather that the purchaser is greatly lacking in necessary information. Meters for measuring voltages, currents and resistances are simple and familiar, but the oscilloscope will be unfamiliar, and first instrument the servicemen will have bought that re-

quires what may be called a minor education before it can be put to the invaluable service for which it is intended.

Therefore it is necessary for the buyer to get all the information in printed form. There are books on the subject. Radio periodicals print a great deal about applications of the 'scope. Also manufacturers of cathode ray tubes and complete 'scopes have an abundance
(Continued on following page)

(Continued from preceding page)

Only one output connection is needed, and that is made to antenna post of the receiver, along with the set end of the antenna leadin. As one tries to find short-wave stations, the presence of any station is denoted by a tooting sound. The device should be connected to the line while station-hunting is in progress, and is turned off by a switch (which may be in series with the line feed to the tooter) after a station is found and one decides to settle down to enjoyment of its reception.

No matter if the station is weak there will be a result, because the note depends on the sum of the two strengths, and if the station

voltage source is weak, it nevertheless adds something to the multivibrator's own effect.

WORKS ON ANY SET

The tooter may be used in conjunction with any type and size receiver, even a crystal set, for that matter. The line feed may be brought through the customary cable to a free-switch at the end of the cable, and the lead hidden behind the console when not in use, otherwise being brought forward to the operator's hand. For table model receivers the tooter may be permanently located under the table, with switch handy at front, the connection of multivibrator output to the antenna post being permanent in all instances.

(Continued from preceding page)
of data. Particularly those supplied with the instrument are informative.

"Operating instructions, my eye!" the budding servicemen is likely enough to think or say. "These bulky sheets are a full correspondence course!"

WHAT USUALLY HAPPENS

And that brings up the subject of the correspondence schools, the two major ones providing very excellent information about the use and application of the 'scope.

Here is what usually happens when a fellow gets that much-desired 'scope:

1. He wiggles the controls until he finally gets a glob of a glow and leaves it on too long for long life of the tube. The fixed beam wears out the fluorescent materials, causing a permanent dark spot, and in certain unusual instances of careless duration, a hole was burned in the glass envelope. The spot should be moved immediately it appears, and the sweep circuit will do just that.

2. The operator gets the sweep circuit working. Thus what was a glob of light becomes to the eye as a broad line. The sweep is used as the horizontal deflection, so the line is from left to right, near the middle of the bulb.

3. Not knowing what else to do for the moment, the operator finds the horizontal line should be moved up or down a little to be exactly in the middle of the screen (as if that mattered too much), and rectifies this condition. Then after adjusting the brilliance and focus controls until the weight of the line just suits his eye he . . .

4. He does nothing, not knowing what to do next.

HERE ARE THE SUGGESTIONS

So a few suggestions are in order. First, he should get access to the a-c line, and, putting in only a few volts to the vertical amplifier, while the linear sweep (saw-tooth oscillator) affects the horizontal, should look at the wave shape. He will get some experience trying to make the pattern stand still. This is largely a matter of having the right screen frequency and amount of synchronization voltage automatically supplied from within the 'scope, both subject to external control. The frequency of the sweep should be equal to or submultiple of the line frequency, and if not it is made so. One complete "wave" means the frequencies are equal, two waves that the sweep is $60 \div 2 = 30$ cycles, three that the sweep is $60 \div 3 = 20$ cycles, etc. It is of no importance how many cycles appear on the screen, only that they be a whole number. Starting the trace, follow it to its first rise or fall, then return to the base line, then continue in the opposite direction and come back to the same level as the start, to trace one "cycle," where there is only one. If the beginning and end are on the same plane, whether

for one or more cycles, the necessary whole-number condition exists.

Now work the controls, seeing particularly that the vertical gain control alters the height of the pattern, reducing it to zero for one extreme control position, and that the width of the pattern is controlled by the horizontal gain device.

SHARP LITTLE TEETH

The other controls may be worked according to instructions obtained with the instrument, to see that they do produce a difference, at least, for the operator is assumed not to know enough about a 'scope yet to decide whether performance is fully satisfactory in every particular.

Before turning off the 'scope and getting right back to reading matter to find out what the 'scope is all about, and why, a test should be made to ascertain whether the beam can be concentrated practically to a pinpoint, with gain controls off or at zero, the spot being left there not more than two or three seconds, whether or not pin-point success greets the attempt. The next thing is to hang a wire from the vertical input red post, just letting it dangle. Now turn up the vertical gain all the way, come back, if need be, should the pattern prove too high, and turn on the sweep. Use all sweep settings and try to make the pattern stand still. Succeeding again, consider what you are observing. It is not the a-c line voltage pattern, because that looked uniform before, a sine wave. The present image has sharp little teeth sticking up from the sides of lines constituting the pattern, and is lopsided at that, even perhaps having a much higher amplitude on one side of the base line than on the other. Actually the base line is carried in the mind, as the eye sees it not now.

TRUANT ELECTRICITY

What you are observing is the wave form of the loose electricity in your location. In cities this may run high, and especially in industrial centers. So with no intended input you have an input. Question: Will it interfere with later measurements? No. When you take some concrete unknown, like the line voltage, and particularly if two-sided input is used (high to red, low to black), the effect of the truant electricity disappears.

Just before going to the books, pamphlets and instructions for more information—and you need the information as much as you need the 'scope—notice whether in some good, clear pattern, there is an equal distance between cycles. Are they crowded toward the tube sides? Then the saw-tooth circuit is not linear. This may be due partly to the amplifier, but without some remedy, up to the manufacturer to produce, the timing oscillator will not yield real linearity of output. Just try overloading the sweep oscillator, by turning up the horizontal gain control until the ends of the pattern are off screen. Linear? Nearly so? I thought as much. A little overloading—and it is harmless—does a lot of good in this particular case.

Now, to the books!

Resistance and Voltage of Line Cords for "Universals"

By Jack Tully

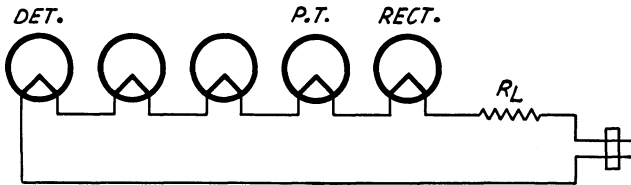

Typical example of a "Universal" receiver's heater circuit with limiting resistor R_L . All five tubes must take the same heater current.

HERE is such a wide use of line cords that the selection of the proper resistance and wattage rating becomes important. Recently manufacturers have favored computations based on a line voltage of 117 volts, as they say that frequently obtains, although the nominal rating may be 110 volts.

Four factors enter to alter the resistance value. One is the nominal line voltage, another is the current drawn, still another is the number of tubes and fourth is the voltage drops across them. To simplify the situation we shall assume that 117 is the figure of voltage, and any resistance values derived from a computation would be ascribed the nearest whole number in even fives or tens to conform to commercial practice. It should be understood that accuracy to one ohm is not required or necessary.

A typical instance, where all tubes draw the same amount of current at voltage drops across each that may be equal or unequal, is shown in the diagram, where also is given the correct order of connection of the heaters of rectifier, power tube (P. T.) and detector. The other tubes' heaters may be connected at will. Notice that the detector is connected to one side of the line, and in a superheterodyne that would be the second detector.

WHAT VOLTAGE IS MEANT

Now, the resistance of the line cord, R_L , is determined by Ohm's law: resistance in ohms equals voltage in volts divided by current in amperes. However, the voltage meant in this application is the potential to be *dropped* in the limiting resistor. It is therefore a difference and that difference is decided by the rated voltage drop across each tube's heater. Here we have five tubes, and assuming that each of them requires a voltage drop of 6.3 volts, we have a required total of drop across heaters of the sum of the separate heater voltages, or the product of the voltage of one and the number of tubes. For five tubes it is therefore 31.5 volts. If we accept 117 volts as the nominal line voltage, then the voltage that affects the formula directly is the difference between 117 and 31.5 volts, or 85.5 volts. It has been assumed the

current required for each heater is the same, and that indeed would be necessary for the simple series connection as diagrammed to apply, and therefore as the current is .3 ampere the required resistance value is $85.5 \div .3 = 285$ ohms. But 5 ohms one way or another would not be serious.

It is a rule of electricity that the wattage is proportionate to the resistance if the current is constant, and as the current is considered constant, we know that the greatest wattage dissipation will be in the line cord of greatest resistance. Therefore to drop the maximum voltage we would have resort to the one-tube circuit, as for more than one tube the extra tube or tubes would drop voltage in themselves, and take that much of the burden from the limiting resistance.

30 WATTS SELECTED

So if we want to play as safe as possible in wattage rating, and yet not require too exacting a wattage for the extreme one-tube case, we may decide the wattage for a single tube example, and apply the same rating even if fewer tubes are used, charging the difference to conservatism. Thus for a single tube the voltage at stake is the difference or $117 - 6.3 = 110.7$ and the resistance value is $110.7 \div .3 = 370$ ohms, the wattage rating being $I^2R = .09 \times 370 = 33.3$ watts. The nearest convenient wattage in round numbers would be 30, and so we shall say that for .3 ampere tubes the line cord should have a wattage rating of no less than 30 watts, regardless of the number of tubes used, but provided they are not so numerous that no line cord at all is required!

Another way of arriving at the wattage rating is to multiply the voltage by the current. Again the voltage meant is the drop, and this is $117 - 6.3 = 110.7$. The current is .3 ampere. The product is 33.21 or, roughly for our present purposes, 30 watts.

We find that the resistance required for a single tube is 369 ohms, and may be of the commercial 370 or 365 ohms, without material difference in results as to voltage across the
(Continued on following page)

Automatic Timer Warns Talkers When to Stop



Talker being warned at WGY. Inset shows time-setting mechanism.

Speakers at the General Electric Company plant in Schenectady, N. Y., need no longer worry about running over their allotted time. The chairman's problem of handling several speakers on one program has been simplified by an electric time reminder.

The device automatically flashes a warning to the speaker two minutes before he is to finish his address. When this period has elapsed, the word "FINIS" is flashed on the reminder and a low toned chime notifies him that his speaking time has ended.

The control device for the reminder may be located on the chairman's table, or, in fact, anywhere in the room. It is a small portable apparatus with a calibrated dial on the front, which may be set for any duration of time

up to 30 minutes. If the speaker is to talk for 10 minutes, the control is readily adjusted and the two-minute warning will flash to the speaker at the end of eight minutes.

A Telechron motor in the control operates a set of switches which in turn operate small relays in the reminder on the speaker's table. The equipment, which is portable, operates on 110-volt, 60-cycle power and may be placed in operation by simply plugging into an electric outlet.

The equipment is also adaptable to radio station use. Instead of flashing a warning in minutes, a signal, rated in seconds, can be illuminated on the screen and the tone chime may be disconnected.

The "minutes warning" is illustrated.

(Continued from preceding page)

tube, because either one volt or four ohms is small compared to the total resistance of R_L .

As to the wattage rating, since the factor .09 is near .1, we may determine the approximate wattage for resistors used with more than one tube by dividing the computed resistance by ten.

When we compute the resistance required for two tubes we find that it is 348 ohms, and use 350. For three tubes it is 327, we use 330. The difference runs about 20 ohms per tube, and therefore on the subtraction basis we may construct a table as follows for any num-

ber of tubes up to the total likely to be included and a bit beyond:

No. Tubes	Resistance of R_L	Actual Wattage
1	370	33.3
2	350	31.5
3	330	29.7
4	310	27.9
5	290	26.1
6	270	24.3
7	250	22.5
8	230	20.7
9	210	18.9
10	190	17.1

Pertinence of Impedances

Matching Applies to Many Circuits

By Edward Duff

A double-button microphone connected to the primary of a matching transformer, secondary feeding the grid circuit of an amplifier. Another matching transformer is used at the output.

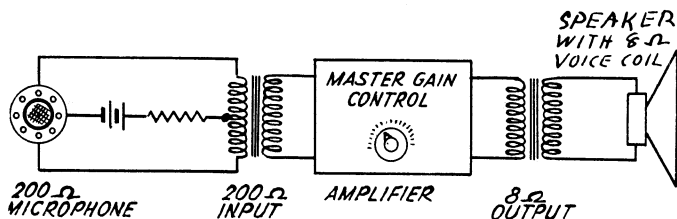

SOME microphones may be connected directly into the grid circuits of amplifiers and some may not. The reason is that the grid circuit represents a high impedance, which means that it causes a large total opposition to current flow, so that to get the largest transfer, the impedance connected to the grid circuit must be large. The connection referred to is known as parallel, because the load is connected across the grid-to-ground circuit. Those microphones having high internal impedance usually may be directly connected. The others may not.

The only practical way therefore to utilize a low impedance device, like a carbon microphone, is to insert a transformer between the microphone and the grid circuit. The primary of the transformer should have an impedance equal to that of the microphone, or approximately so, while the secondary, connected to the grid circuit, has the requisite high impedance. In that way loss is avoided and quality is served besides.

THE TWO CARBON MICROPHONES

If one has a microphone he may not know its impedance, but can ascertain the fact from the manufacturer of the device, by stating the model number, and preferably adding the serial number, if such extra number is imprinted anywhere on the device. Then the matching transformer may be obtained from a transformer manufacturer or a radio store or catalogue house. Failure to utilize the transformer at all, for electrically equalizing the coupling, or impedance matching, is a very serious fault, and although rarely committed, nevertheless probably is an actuality in some experimental installations among beginners.

If the microphone is of the carbon type it may be either single-button or double-button. At present the single-button type is not used very much, except for purposes not related to quality at all, as in some industrial measurements, and for remote control emergencies, but the double-button type is still prevalent,

and requires a center-tapped primary on the coupling transformer.

Both types of carbon microphones require an excitation voltage, and usually a 4.5-volt small dry battery suffices. For the single-button instrument the battery is simply connected in series with the primary, and the polarity is not significant.

THE STRETCHED DIAPHRAGM

For the double-button variety the connection is made as shown in the diagram, the series resistor, though shown fixed, usually being a rheostat, so that the direct current may be kept below the maximum prescribed by the manufacturer, which may be around 15 or 20 milliamperes. Often a jack type of panel outlet is used so a meter may be plugged in to read the current. The check is made prior to each use of the microphone.

The carbon microphones in general are the most economical, especially as to purchase price, and quality is passable on speech, but they are not the best for music, or wide frequency coverage, unless they are of a specially constructed type, with stretched diaphragm, this being a much more expensive instrument, and nearly always double-button.

It can be seen that the double-button microphone works in push-pull fashion, and therefore favors better quality, especially because of the practical elimination of the even order of harmonics. Add to that the stretching of the diaphragm, which at once reduces sensitivity greatly, and increases quality at the same time, and you have a microphone of very acceptable performance, especially for portable or mobile use, because of the additional advantage of ruggedness.

The diagram shows a double-button microphone connected in the primary circuit of the matching transformer in the correct way, with high impedance secondary leading into the amplifier. The volume control on the amplifier is called a gain control, and the adjective *master*

is used because this control would be effective upon any systems connected to its output, whether they were additional amplifiers or speakers.

THE SITUATION REVERSED

When the speaker is considered, again the matching of impedance arises. The plate circuit of the power tube in the amplifier has a high impedance compared to the impedance of the voice coil of the speaker, assuming a dynamic speaker. Usually the voice coils are of impedances of 12 ohms or less, 8 ohms being extremely common. It is therefore obvious that the very reverse of the microphone example exists now, because with the microphone we had a low impedance output and required a high impedance input, and now we have a high impedance output and require a low impedance input. What goes in to the grid circuit in the first example, or into the voice coil in the second example, is the input.

So all we do is to turn the transformer around, figuratively speaking. Actually we have a different transformer, different because the impedances are different, and also different because we have to make provisions at the power tube for handling power, a consideration that never arises in connection with a microphone. Nevertheless the principle is the same.

It is not always true that the impedances must be equal. That is, the primary impedance of the output transformer may not be just the same as the plate impedance of the tube to which it is connected. The maximum power transformer takes place when the impedances are equal, but besides power we have to consider voltage and quality, and the theory of utilizing twice the source impedance as the load impedance is favored from a voltage viewpoint.

SIMPLIFIED BY CHARTS

However, the power tube matching problems is greatly simplified because in tube characteristics charts, for the specific purpose to which any power tube is applied, including the "class" of power amplification, the ohms load is stated, and the primary of the output coupling transformer should have just that impedance for best quality consistent with adequate transfer.

If a certain impedance load is required for a single-ended amplifier, usually twice the impedance (plate to plate) is required for a push-pull output. Thus, for 7,000 ohms load, single tube, 14,000 ohms load may be recommended for push-pull. Again, other considerations, affecting quality, arise to amend this, and somewhat less than twice the impedance load may be recommended for push-pull applications, on the basis of experimental findings that are related to the performance characteristics of the tube.

Not only the tube itself, its B voltaging, and its use as a power amplifier, determine the ohms load required, but the grid bias has a considerable effect. For instance, every experimenter knows that when he increases the negative bias on a tube, if the B voltage is main-

tained constant, the B current declines, whereas if he decreases the negative bias (moves the grid electrically toward positive), the B current rises. The current is a measure of the resistance of the tube. Therefore the bias change increases the plate resistance for increased negative bias, reducing it for less negative bias. Hence the ohms load takes into account the bias operating point, at no signal input, therefore the negative bias must be as recommended.

APPARATUS TO SUIT PURPOSE

So if one type or class of power amplifier may be built with two equal output tubes, with certain B and C voltages, varying considerably the bias will convert the output to another type. One example is Class A, which allows for no grid current; Class AB, which allows for a little; Class B, which allow for positive grids, and Class C, which is practically a voltage "doubler" with tubes operated near cutoff.

Besides the different ohms loads required for the different classifications of power amplifiers, the type of apparatus used has to be different if there is grid current. The winding through which this current flows must have low d-c resistance, to reduce power loss to minimum. Also there must be a suitably powerful driver for the output tubes, where grid current is permitted, so that there will be an input power supply that relieves the output tubes from devoting their own power to their own grids, which introduces additional distortion.

The special amplifiers, of the Class B or grid-current type for instance, distort badly on weak signals, but on very powerful ones usually give much less distortion, for the same B voltage application. However, these special output circuits never gained any popularity in receivers, as so often sets are operated at low volume that the public listens to more distortion than quality. Without being particularly tone conscious, the listener would say that the set did not play very clearly.

DETECTOR WEAKEST SPOT

The detector is probably the weak spot in receivers and in the detector, too, the impedance situation arises. Generally diode second detectors are used in superheterodynes. These afford much better quality than the usual triodes, quadros, pentodes, etc., but they draw current from the i-f amplifier (secondary feeding second detector or demodulator), lower selectivity, and besides they require the impossible, that the a-c impedance of the audio load be equal to the d-c resistance of the diode load resistor. This can not be because all connections to the d-c load resistor for the purpose of taking off the audio effectively put in parallel another impedance, and the result of putting two impedances or resistances in parallel is to reduce the effective value to less than the value of either alone. Thus a limitation arises, which means in brief that very high percentages of modulation can not be handled without distortion.

There are several ways around this problem,
(Continued on following page)

CHASSIS DESIGN

And Its Effect on Receiver Performance

By Herbert E. Hayden

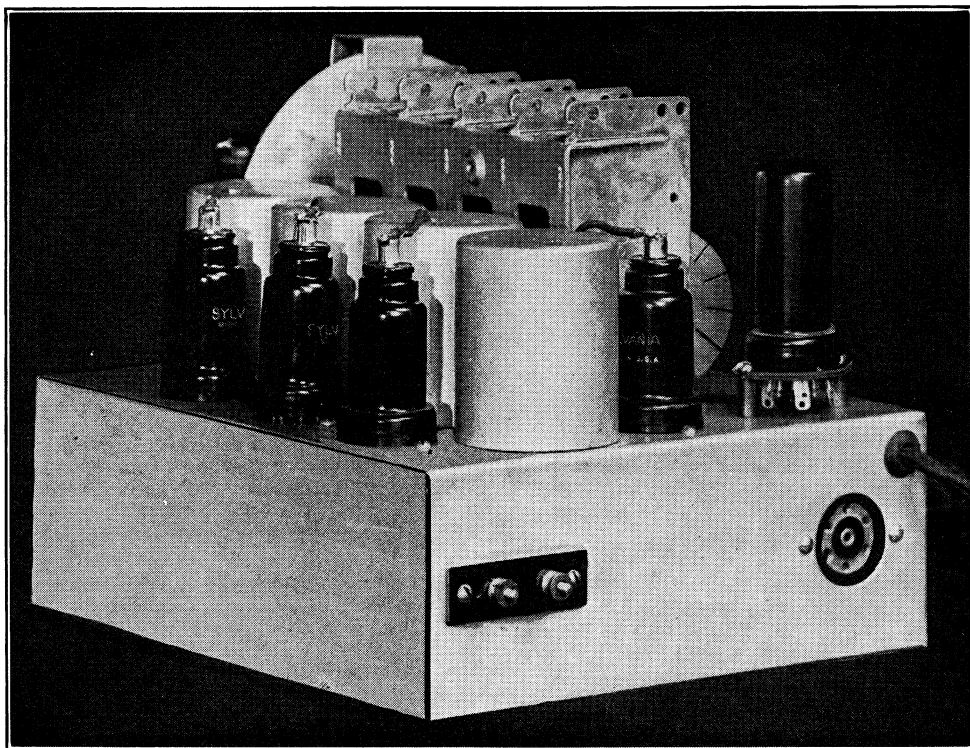

The ground post is one of the two on the black oblong at chassis rear. For the standard broadcast band the post is connected to chassis by solder and by bolt-and-nut affixation of a lug. Thus chassis may be used for ground, but for short waves it is sometimes necessary to run independent ground leads directly to the ground post, to minimize chassis currents.

ONE of the problems requiring most adroit engineering in the design of a receiver is the chassis layout. A large number of experimenters is equipped to prepare its own classes, having circle cutters, punches, drills, etc., and the mechanical work reflects to a large degree the ensuing electrical performance.

An axiom in chassis layout is to make all leads as short as possible, but this is just another of the perplexities obsessing radio design work, because some of the leads must be necessarily long because it is impractical to pyramid parts, and also the chassis as a whole

must be utilized, and no concentration of all material permitted about some focal point.

CHOICE OF FREQUENCIES

The shortest-lead rule therefore would be applied to radio frequencies rather than audio frequencies, the compromise being satisfactory because audio leads are not subject so much to stray pickup from the capacity and inductance of the connection wiring. By the same token, the highest frequency leads are

(Continued on following page)

(Continued from preceding page)

made shortest, so that if the receiver is to cover two or more bands first attention would be devoted to the shortest wave band, and coils located as close to coil switch and tuning condenser as is practical, and then the next best choice is made for the benefit of the next longest wave band. If there are three bands, and the third, in ascending wavelengths, represents the standard broadcast band, then the connections to parts serving this band would have to be the longest, so far as radio frequencies go.

Following the same sequence to longer waves, or lower frequencies, if the receiver is a superheterodyne, the intermediate channel must be given attention. Fortunately this is physically separate from the mixing division, and is usually in some sort of aligned cascade arrangement, not introducing much danger of back coupling, except for automatic volume control leads or for

sured low impedance to radio frequencies, particularly high frequencies. A separate paper condenser is advisable wherever the B plus lead is picked up through a resistor or separate choke for r-f, oscillator and i-f circuits, but if they are one lead, the single condenser across the electrolytic suffices.

The radio-frequency coils commonly are put in a row, as nearly opposite the tuning sections of the tuning condenser serving them as is possible. The condenser section will be of less width than the diameter of the coil shield, assuming coils for the standard broadcast band, which, in three or more gang condenser installations always are shielded. The shields of course are grounded.

THE GROUND POST

The illustration on the preceding page shows a side-rear view of a standard broadcast set of

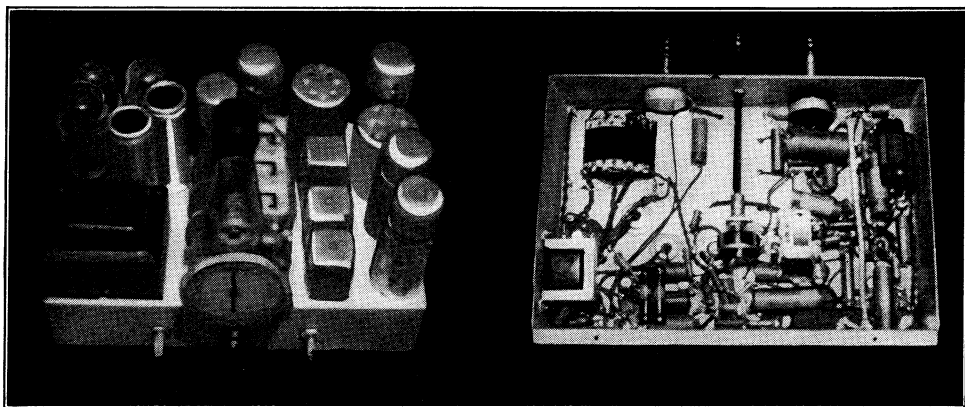

Top and bottom views of a standard broadcast band receiver, with superheterodyne, with the extension shaft introduced to make the connecting leads to the volume control very short.

two-stage channels. It is therefore easy enough to make the plate-to-coil leads at the i-f level short, also to bring the returns of the grid circuits to ground by the shortest path, or immediately to the filter resistor, and bypass the resistor as close to the coil as possible, to ground. With the high resistance values, and relatively large capacities, permitted it is no task to maintain leads free of trouble.

AVOIDING OSCILLATION

The main problem connected with the intermediate channel is that if it is two-stage (three coils) it will have a tendency to oscillate, and the proper chassis arrangement is in part a safeguard against that, by enabling the short leads to ground already mentioned. The B plus lead is considered grounded also, from an i-f viewpoint, because a large capacity is across the B plus to B minus circuit. If this capacity is an electrolytic, it is always helpful to put a 1 mfd. paper condenser, of 400 volts rating, across the final B filter condenser, so that there will be offered an as-

the service-shop-built variety, with the shielded coils following the customary alignment. Here, however, we have a four-gang condenser, and the circuit would naturally be of the tuned-radio-frequency type, as there are no intermediate frequency coils or tubes shown. For local reception this type of receiver is satisfactory, considering only the standard broadcast band, but if one were to include short waves, naturally for best results the circuit would be a superheterodyne.

There is shown a twin assembly of antenna and ground posts, at left rear, in the aforementioned view, and the ground post is connected directly to chassis, as near the post as practical. This connection must be cautiously made. Most chasses are cadmium plated and cadmium is not inviting to solder. It would be well to drill a hole and bolt a lug right close to this point, soldering the ground post rear projection to the lug. Also, scrape off the cadmium plate, and applying what might seem as a gross excess of resin flux, use a very hot iron (100 watts minimum), and also solder

a stout, short copper bar from lug to chassis where chassis has been cleared of the plating.

Whenever the chassis is used as a ground elsewhere, there are always some currents present in the chassis, and this may be confirmed by the touch test, as a faint click may be heard in 'phones or speaker when chassis is touched at some point remote from the ground post, to which external ground is deemed connected. It is obvious that the grounding of the chassis is not perfect at points removed from the post, and so if any resort to chassis as ground must be had as acceptable compromise for the standard broadcast band, the same precautions about nut-and-bolt lug connection and soldered adhesion apply.

audio leads, and the likelihood of trouble still would remain small, and the same applies to the heater supply leads, but it is always good practice to use twisted pair, because such type of wire to some extent neutralizes the stray currents.

The combined top and bottom views of a chassis represent a broadcast band superheterodyne, with square shields enclosing the r-f and oscillator coils, and with the two intermediate coils adjacent, one behind the modulator input coil, the other behind the shielded pentagrid converter tube. A three-gang condenser is used.

As there is only one i-f stage (two coils used), the likelihood of any oscillation trouble

Arrangement of the chassis for a seven-tube single-band superheterodyne. The meter at rear of the three-gang condenser is experimentally present for alignment purposes. This circuit has three i-f coils, hence two i-f stages of amplification. There is an ever-present peril of oscillation, hence the leads must be short for this i-f channel, also the filtration particularly good. Resistor-capacity filters in the plate return leads are sometimes used to augment other filtration.

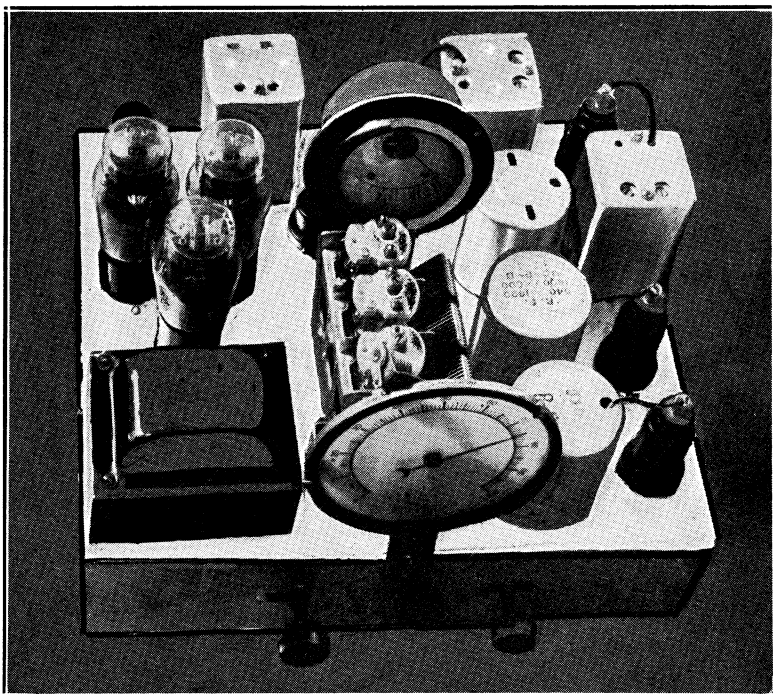

But if short waves are concerned, the ground currents may be avoided by running separate copper leads direct to the ground post. Therefore in arranging a chassis for short-wave work, the disposition of parts, particularly coils, should be such as to facilitate the shortness of the lead to true ground. It must be remembered that as the frequencies become higher and higher true ground become more and more elusive, until finally, above 20 mc, it seems impossible to establish a completely satisfactory ground. This is because all leads intended to produce grounding have sizeable impedance at these high frequencies.

LEADS FOR B SUPPLY AND A.F.

The B supply leads may be long, as may the

if very small, unless the chassis is grossly misarranged. In fact, the one-stage channel will stand considerable gain improvement, without oscillation danger, and that is why for such channels it is not unusual to include i-f coils that have high-permeability iron cores. These improve both the selectivity and the gain. The serious problem of oscillation trouble being avoided, it is recommended that those not thoroughly versed in radio technique, if they are to build a super, rely on the designs that surround the single i-f amplifier tube.

The underneath view shows how a chassis difficulty is avoided. It is slow work to get engineers to resort to mechanical means for shortening leads. Here the volume control is a potentiometer which acts as the d-c load also

(Continued on following page)

(Continued from preceding page)

on the diode second detector. Naturally the tube and coil associated with this second detector are rather remote from the panel, where access must be provided to the control knob. The simple expedient of introducing an insulated extension shaft permits the control to be where it should be, near the diode, and yet the knob is at the front panel.

SPEND THE NECESSARY TIME

No pains should be spared to introduce these mechanical assistances to excellent performance, even though some special fittings must be

bypass condenser, and even B choke coil, as in the photograph.

Where a person has a special fondness for a cabinet into which a radio set is to be put, of course extreme care must be taken to obtain the inside dimensions of the cabinet, and to make the chassis small enough for insertion with ready clearance. Then the tuning condenser position is allotted, usually conventionally, as shown in the top angle view of the chassis with meter at rear. The power transformer may be at left front, as shown, or at left or right rear, but the arrangement depicted in the photograph is easy to follow for

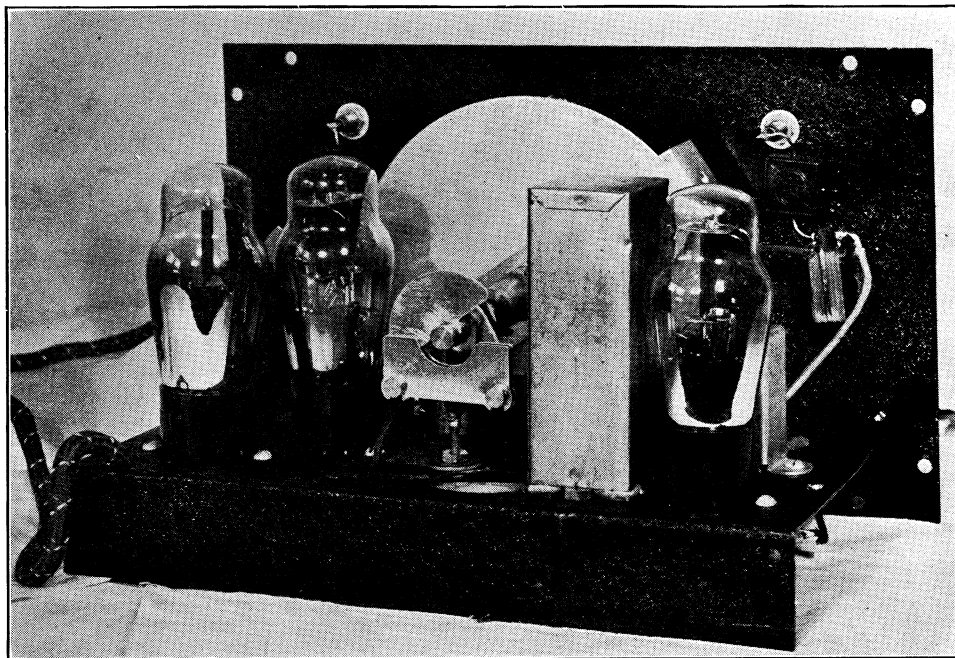

For short-wave sets of the simple type, using plug-in coils, a conventional chassis design of proven excellence is illustrated.

made, and more time taken than some would suppose justified. Yet since the object is to attain as high results as practical, the extra time simply must be devoted, especially since those who are to use the set will judge it only on the results, and without regard to the extended care conferred on attaining them.

Actually a custom-made job is not of financial advantage, and owes its existence to the never-extinguishable hobby of a large number of men and boys to make things themselves, and to the occasional demands of friends for installations to meet certain requirements of cabinet space.

ALIGNMENT METER

The side walls of the chassis may be used for mounting some parts, particularly flat type

a seven-tube set. The seventh tube is hidden by the meter.

By the way, this meter was put in place only temporarily, and measured the voltage drop across the cathode biasing resistor of the intermediate amplifier tube. Since a.v.c. was used, the i-f channel was aligned, using a weak input from a signal generator, by noting minimum reading of the voltage. Thus the last i-f tube was used as an uncalibrated tube voltmeter.

Sometimes a request is received for building a short-wave set, possibly using plug-in coils. A socket behind the condenser, as in the final photograph, may be used for the coil, assuming a simple regenerative receiver, where one tube is rectifier of the a-c supply, another is the regenerative detector, and the third an audio amplifier for adequate volume on earphones.

TELEVISION IN 3x4-FOOT SIZE SEEN PUBLICLY

The purely experimental feat of the Radio Corporation of America in attaining television projection on a screen 3x4 feet, of size comparable to home movies, was demonstrated recently before members of the Society of Motion Picture Engineers, at Radio City. The transmission originated at the Empire State Building, where the National Broadcasting Company's sending facilities are located, and was picked up at Radio City, nearly a mile away, and converted from carrier frequency to video frequencies for amplification to excite the cathode-ray receiving scanner.

A projection tube developed by Dr. R. R. Law, of RCA Manufacturing Company, was the basis of the demonstration. Ordinarily the pictures shown are 7x10 inches, or by the new method size was 24.7 greater than that of the standard showing. The observers, being acquainted with the magnitude of the problem of enlarged projection, with the great loss of light by the inverse square law, and other obstacles, were impressed by the demonstration as an experimental advance, although privately admitting that the results were not adequate for the public. This fact is admitted all around and applies to television generally, not only to the enlarged projection.

SHOWN IN DARK ROOM

Sound accompaniment was demonstrated, also, but was not considered as good as that which was simultaneous with the demonstration of the smaller-sized picture. The sound, on the smaller scale television, is of the high-fidelity type, and remarkably better than that usually attending broadcast reception.

The large picture was demonstrated in a dark room, under conditions similar to those obtaining when home movies are shown.

David Sarnoff, president of the Radio Corporation of America, made a few remarks. He said in part:

"Television today is an unfinished product, but it is advancing, and I foresee the day when it will produce another vigorous industry which will provide many new avenues of employment."

BULKY APPARATUS

One of the pictures showed a pianist in close-up and at long range, while the music he played was heard.

The apparatus used was bulky and occupied

Radio Gimbal Provides Strong Cradle for Chassis

Several manufacturers have brought out recently devices very helpful to the serviceman because permitting the chassis to be gripped while in work and turned to different positions, including odd angles making for easy access. One of the best of these is known as the Radio Gimbal, a chassis cradle manufactured by William A. Thomas, 321 Caroline Street, Neenah, Wis.

This chassis cradle is made in two types. They are the same, except that one model, the Senior, has two swinging frames, while the other, or Junior model, has a single swinging frame.

Either model holds the chassis in any position for speedy servicing, and accommodates all sizes of chassis, up to 13x21 inches. It is pointed out that a well-engineered, sturdy chassis cradle eliminates fatigue in reaching for otherwise inaccessible points at which to solder or examine, and that servicing costs to the operator are considerably reduced. The greater turnover, at no reduction in customer prices, makes the use of such a device remunerative.

Another use for the Radio Gimbal is for purposes of displaying a chassis, as for window exhibition or use at shows. Specially attractive chassis, sometimes chromium plated, are obtainable from some set makers for advertising purposes, and often prove very attractive business getters.

Two years of developmental work preceded the production of the Radio Gimbal.

The model with two swinging frames (Senior) is priced at \$6.00 while the Junior model (one swinging frame) costs \$3.50.

more room than would be conveniently practical in an average home. Some of the guest engineers commented that there would have to be considerable simplification and "compactification" before an instrument of that type is offered to the public, even when the results are on a par with commercial requirements.

\$10,000,000 ALREADY SPENT

The outfit, as it stands, is also excessively costly, and prohibitively beyond the purse of private individuals, except the enormously wealthy. In fact, before Dr. Law's theories were reduced to practice some hesitancy was felt about incurring the large expense, but after the assent was given the development proceeded steadily, and it was an eye-opener that the system worked as well as it did, considering the immensity of the difficulties.

The increased size pictures therefore added another large amount to the vast expenditure already made by RCA in television, including the activities of the two subsidiary companies, the RCA Manufacturing Company and the National Broadcasting Company, running into \$10,000,000.

PHILCO BACKS CHARGING FOR INSTALLATIONS

Should a serviceman or dealer charge for installation of a set he sold, and for giving personal operating instructions? The rule has been to charge nothing, but it hasn't worked so well, because absence of pay was no incentive to careful work. Sometimes the customer was simply left to his own devices.

Philco has taken a step to back up selected dealers and servicemen in its franchise group in charging \$7.50 for a year's service. This binds the dealer to set, align and thoroughly test the receiver before delivery, erect aerial and make two service checks within a month after installation, the final call involving 14 tests. Gimbel Brothers, of Philadelphia, was one of the first of the leading department stores of the country to become a franchise holder.

MAY ADD CHARGE "ON TIME"

It is permissible to add the \$7.50 item to the cost of the set and thereby increase the time payments by 15c a week.

Philco has laid down requirements for prospective franchise holders, including adequacy of equipment, high personal and technical qualifications and constant supervision by distributor and the home office.

According to Robert F. Herr, manager of Philco's Parts and Service Division, the plan "is in no way to be considered as a means of getting service work or repair work for any dealer or serviceman. Dealers have been faced with an installation problem during the past few years that has become increasingly important and in many cases quite serious to them." He added:

"It is true that some people might say that the work incident to the installation of a radio and aerial are expected by the customer and that therefore the dealer should perform these operations free of charge. However, since the dealers have had no income from this work, we have found at times they neglected or did it in a hurry or haphazard manner.

REASONS FOR MOVE

"We would like to see every dealer do the things outlined in the Philco Guarantee Plan at no charge to the customer. But most dealers will not go this far in making sure that every customer of theirs is 100 per cent satisfied. Because it is difficult to get all dealers to do these things properly at no charge and because radio sales are depending more and more on the correct installation and the correct instructions that are given to the owner, we are helping the dealers by backing them up in charging for this necessary work."

Board Clearing 455 kc To Stop Interference

Washington.

The Federal Communications Commission has adopted the request of Radio Manufacturers Association, Inc., for establishment of the frequency 455 kc as a protected intermediate frequency for the radio set manufacturing industry. The Commission will endeavor to protect this frequency, set aside in the manufacture of receiving sets, by not authorizing any new frequency assignments in the band from 450 to 460 kc. If future service requirements necessitate a change in this announced policy of the Commission, the Association will be advised of any contemplated action.

Request for the 455 kc band was made last year at the Commission's general hearings on allocations.

If there are no stations on or near 455 kc, and if manufacturers use 455 kc for receiver intermediate frequency, interference from 455 kc waves due to direct pickup or riding through, will be eliminated.

Freak Addresses Delay Mail to British Stations

London.

A drawing of Broadcasting House with the word "London" written below it was how one listener to Daventry addressed a letter intended for the British Broadcasting Corporation. In this instance, the letter reached its destination safely, but listeners who are anxious that their communications should arrive swiftly and surely are advised to use the conventional method of addressing their envelopes. Envelopes bearing obscure or puzzling superscriptions are liable to be returned to the sender by the Post Office marked "insufficiently addressed."

Many correspondents address their letters to "GSA (or other call-sign), Daventry, England." Daventry, however, is the site of the transmitting station only, all correspondence being dealt with at Broadcasting House, London. Letters addressed to Daventry may ultimately reach their proper destination, but considerable delay in delivery is likely to occur.

The BBC receives many letters from oversea listeners addressed to "The Program Speaker" or "The Announcer," the senders apparently being under the impression that only one announcer is heard in the program from Daventry. Actually, six announcers are employed in the Empire Service, and it is frequently impossible, therefore, to identify one as the intended recipient. The correct address for all letters to the BBC is Broadcasting House, London, W. 1.

New Designs Offered by Cal-Fon Communication

The Cal-Fon intercommunication system, manufactured the past year by the Universal Microphone Co., Inglewood, Cal., is now being augmented with the addition of several new styles.

Besides the ordinary desk mount used in offices and factories there is a new model of similar design with the mounted box and the French-style 'phone, but with the addition of wall brackets for those who prefer a well intercommunicating 'phone.

The latest development for the Cal-Fon is a model designed particularly for trailer operation, and consists of a desk or wall set for the trailer and also a single handset with press button switch for the automobile cab with a buzzer to mount on the car dash for signalling. The signal from the trailer itself consists of a call button installed in the set.

The French type of box can be mounted on a table in the trailer or placed on the wall. There is a unique spring holder that keeps the French 'phone in position on any kind of roads.

The plug and socket connection makes it possible to disconnect the instrument when the trailer is detached from the automobile.

Trailer diagram No. 86 contains complete information and instructions for the trailer Cal-Fon model.

New Flashlight Screwdriver

Stanley Tools offers a small sized pocket "Flash-Lite" screw driver with a clip. It has been designed for use by radio, refrigerator, auto and oil service men who need a handy sized screw driver for working in dark places. The handle, octagon shaped, is made of brass and is finished a crystal black with a contrasting orange stripe. It holds one standard battery and light bulb. The screw cap and clip are nickel plated. The blade, two inches long and $\frac{1}{8}$ inch in diameter, is made of tempered steel and has an accurate machine cross-ground tip. Battery and bulb can be replaced easily when worn out. It is manufactured by Stanley Tools, New Britain, Conn.

A Christmas Gift for Him

Is your husband, son or nephew interested in radio? Why not send him Radio World for the coming year?

We will send him, at your request, a Christmas Card, to arrive before Christmas telling him of your thoughtfulness in sending a Christmas gift that lasts all year!

For \$2.50 a year in the United States he will be reminded of your generosity every time the magazine arrives.

**RADIO WORLD, 145 WEST 45th STREET
NEW YORK CITY**

PUSH-BUTTON TUNING PROVES WORTH WHILE

Push-button tuning has put the better-grade 1938 receivers in a strong position, and encourages "trading up." There is an unwillingness by customers to go beyond a certain price, so low-priced, small sets have had the edge. However, last year a trend started toward the better grade sets, and this has been augmented by push-button tuning.

A few years ago automatic volume control was generally introduced. But dials were as usual, and no means provided for the accuracy of tuning that a.v.c. required. Without on-the-nose resonance there was bad distortion, due to insufficient negative bias on strong stations, as not enough of the required extra bias was supplied by the second detector.

Then came the tuning eye, meter or other device for permitting observation of resonance. But persons would tune the set without recourse to the visual guide. Then came automatic frequency control to bring stations in correctly despite a dial setting otherwise far off. Push-button tuning is an advance because when the device is set properly, the station "buttoned" is always tuned in just as it should be.

Ghirardi's Twin Gadgets

Radio & Technical Publishing Co., 45 Astor Place, New York City, publishers of Ghirardi's new "Twin" Pocket Trouble Shooter Gadgets, announce a new special compact combination stand for counter and wall display, which holds six of the Home-Radio Gadgets and six Auto-Radio Gadgets.

The stand is designed so that each set of Gadgets remains in full view, even after some have been sold and removed. These stands are being supplied free of charge (upon request) to those dealers ordering 25 or more Gadgets, who feel they can use them as Gadget sales boosters in their stores. The entire outfit takes up only 5" x 3" of counter space.

SEVEN YEARS' GOOD LUCK

I have been reading your RADIO WORLD for the last seven years, and I have found it very valuable in my experimenting with the radio.

VICTOR SEGNA.

220 East Park St., Butte, Mont.

New Coaxial Cable Fills Servicing Needs

A low loss coaxial cable, CO-X, has been brought to the market as a result of the development of anhygron insulation.

Wherever lead sheathed concentric cable was previously used, or where it could not be used because of weight, inflexibility, or cost, the use of CO-X is possible.

Uses of CO-X are in antenna lead-ins, transmission lines, and feeders; transmission lines between photo electric cells and amplifiers; in circuits where h-f or leakage losses must be a minimum, and similar circuits where radiation or pick up must be a minimum and low leakage is essential.

CO-X is comprised of three components, (1) the braided inner copper conductor, (2) the anhygron separators; and (3) the outer conductor braid. In the past a lead sheath has been necessary to prevent moisture from attacking the insulating material. Anhygron is non-hygroscopic. Besides, it has light weight, high strength, infinite resistance, exceedingly high breakdown voltage (1,250,000 volts per inch) and a dielectric constant of 2.5.

Instead of the frequent supports and cable racks necessary for the lead sheathed line, CO-X can be suspended by its own strength for long vertical drops without intermediate supports. This makes it very useful for apartment houses, where the antenna is installed above the roof, and the ordinary transposed transmission line is difficult to support, and easily short circuited. For coupling between radio-frequency stages of a transmitter it is particularly useful, as it completely eliminates the need of placing successive stages of radio-frequency amplification adjacent to each other, and thereby allows much more convenient arrangement of parts. It might be desirable, for example, in low-level phone transmission to put the final high power stage at some distance from the modulated stage, using CO-X to connect the stages. At the same time, the improved shielding provided by CO-X prevents stray radio frequency power from getting into the audio frequency amplifier.

The serviceman can use CO-X for "piping" the signal from his test amplifier to a set under test, its light weight and flexibility making it superior to other cables. Radio stores, located in places where interference is particularly severe, can produce their own radio programs from phonograph records and transmit them at radio frequency over CO-X to give the customer a fair comparison of tone qualities of various radio sets.

Transducer Corporation, 30 Rockefeller Plaza, N. Y. City, is the manufacturer.

Bulletin Describes New W.E. Aircraft Receivers

A new bulletin issued by the Western Electric Company describes and illustrates the type 20 aircraft receivers and accessories, including modified forms of the receiver which are just being introduced to accommodate those who wish to have facilities for receiving the 500 kilocycle international distress frequency (600 meters).

This publication also announces a new unit known as the D-99018 oscillator. This addition to the Western Electric line of aircraft radio equipment is a simple and compact device which, used in conjunction with the type 20 receiver, permits continuous wave signals to be picked up by producing a beat note of a frequency controlled by the operator or pilot.

Data in the form of descriptions and dimensional sketches are also included in this bulletin covering the 27A remote control unit, which may be conveniently mounted near the pilot's or operator's position with flexible cable connection to the other equipment located elsewhere in the plane. Similar information is included covering the KS-7543 dynamotor power supply unit.

The equipment described is designed to cover the various frequency bands useful in aviation work, such as the beacon signal and weather report band (188 to 420 kc), commercial broadcasting band (550 to 1,500 kc), aircraft-policeman-amateur band (1,500 to 4,000 kc), and the aircraft-amateur-foreign band (4,000 to 10,000 kc).

Superior Has Two New Products and Catalogue

After having established a line of signal generators, volt-ohm-milliammeters and tube checkers, Superior Instruments Company has added two more products, bringing the total to eleven. One of these is a low-priced volt-ohm-meter, using a square type meter, and measuring 0/5/50/500 volts and 0/500/20,000 ohms. The low ohm feature is new in low-priced instruments and is based on the meter shunting method, or kickback reading. The other new instrument is a Multivibrator, which is a signal generator that requires no switching, yet produces an output at all radio frequencies, from 100 kc to 20,000 kc, used for alignment of super-heterodynes and other sets.

A new catalogue has been issued in which all the products manufactured by this concern are described. It may be obtained by writing to Superior Instruments Company, 136 Liberty Street, N. Y. City.

Allied Has New Portable Reproducer and Player

A new, compact, portable transcription reproducer and record player is one of the latest developments offered by Allied Radio Corporation of Chicago. Designed for operation on either a. c. or d. c., this new unit is suitable for use almost anywhere.

Features include built-in amplifier unit with 4 watts output; dual-speed universal phono motor with 12-inch turntable; 12-inch crystal pick-up; built-in scratch filter; tone control; and 8-inch permanent magnet dynamic speaker.

All 8-, 10-, or 12-inch recordings apply.

RADIO CONSTRUCTION UNIVERSITY

Answers to Questions on the Building and Servicing of Radio and Allied Devices.

WIEN BRIDGE

WILL you please establish by diagram the Wien bridge so that it may be used for measurement of resistance and capacities, as well as for power factor? I can compute the values myself.—U. D. F.

The diagram of the circuit, as supplied by Solar Manufacturing Company, which commercially manufactures the device, is shown herewith, and ordinarily we would be glad to supply the values also, but the company prefers that they be not disclosed.

INVERSE FEEDBACK AMPLIFIER

I AM much interested in a push-pull output, using 6L6's and inverse feedback, and would like to know the grounding points for such a circuit you recently published.—I. E.

The diagram is reprinted herewith, and the grounded point, the same lead as B minus, should include the left-hand end of the 200-ohm self-biasing resistor, which is also the center of the two 5,000 ohm resistors close by, and the low side of the filter, as already men-

(Continued on following page)

The Wien bridge is a special type bridge that lends itself admirably to measurement purposes in the radio servicing field. It is shown herewith, with tuning eye as indicator, and with a I-V as the rectifier of the B supply. The bridge may be used for measurement of capacity and resistance, also power factor. The general type of bridge is applicable also to measurement of audio frequencies. Formulas applying to the Wien bridge will be found in Henney's Handbook, for all purposes discussed.

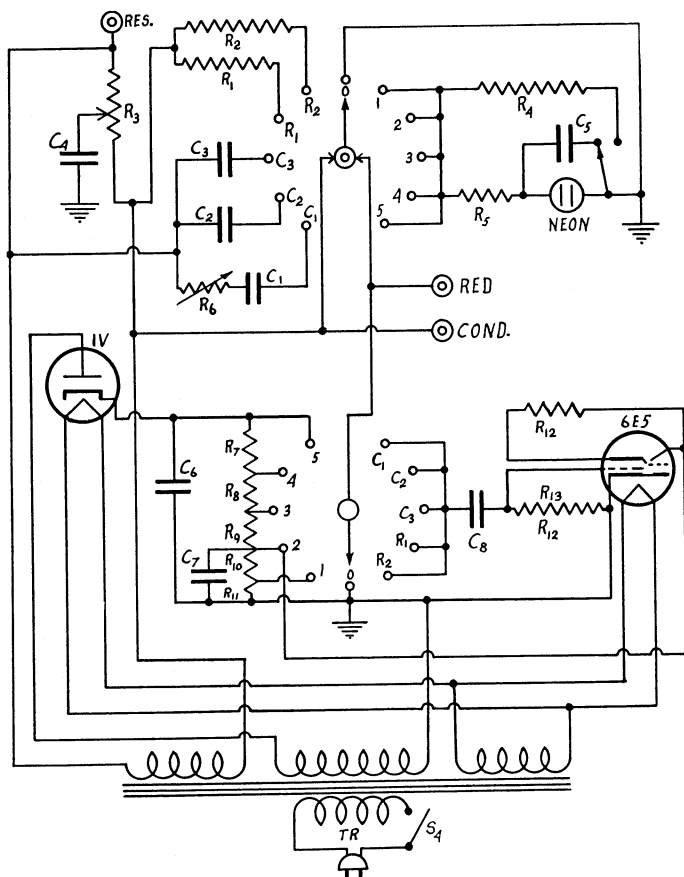

(Continued from preceding page)
 tioned, and actually shown in the diagram. It will be noticed that the secondary of the push-pull input transformer has two separate secondaries, and that the negative feedback resistors are connected between one terminal of each such winding and ground.

* * *

CONSTANT VOLTAGE SUPPLY

CAN a voltage-regulating tube be used in a circuit for absolutely constant B voltage supply? What is the comparative constancy of batteries?—O. W.

Yes. At present most amplifiers and oscillators for radio and commercial applications, and some of those used in the Bell Telephone plant, obtain their plate supply from commercial alternating-current circuits through rectifiers and filters. As a result their plate potential varies both with the load on the amplifier and with the voltage of the a-c supply. In many cases the load is more or less constant, and the variation caused by changes in line voltage has no serious effect; but for amplifiers used for measuring purpose and for all oscillators, the accuracy of the measurement, or the closeness with which the frequency is held, depends to an important degree on the plate voltage of the rectifier tube, so that a supply of constant potential is of considerable importance. Batteries could be used but their operating cost is high; to provide a less expensive installation for such services, a regulated rectifier unit has recently been developed by Bell Telephone Laboratories. It is designed for operation on 115 or 230-volt a-c circuits, and supplies 100 milliamperes of plate current at potentials from 130 to 180 volts, and 50 milliamperes at 250 volts, constant to within a quarter of one per cent regardless of changes in load or in supply voltage. The entire unit is assembled on a chassis only seven inches high and of a width suitable for mounting on a standard 19-inch

relay rack. In brief, the rectifier and filter supply a potential considerably higher than needed for the d-c output. The rectified current is passed through the regulating tube, which inserts a voltage drop that, by means of the control tube, is made to vary with variations in the d-c output voltage.

* * *

FIRST COAXIAL FIELD TEST

WILL you please summarize the results of the New York City-Philadelphia coaxial system of Bell Telephone Company such as is useful for broad-band transmission, including television?—A. L.

The experimental coaxial cable system between New York and Philadelphia was in place and ready for a series of field experiments at the end of last year. Preliminary test conversations have been held over the system, both between New York and Philadelphia and also over a circuit looped back and forth at the terminals to give a total length of 3800 miles. In general, the results thus far obtained have been in accordance with expectations, and no insurmountable barriers have appeared which would prevent the successful application of such systems in the future. Much work remains to be done, however, before coaxial systems suitable for general commercial service can be produced. Although the quality of transmission has been shown to be satisfactory, many other problems require consideration. A more precise system for regulating the transmission to compensate for changes in attenuation will be needed for systems which are to operate over transcontinental distances, particularly where aerial construction is involved. The accumulation of noise and crosstalk over long distances must be kept within satisfactory limits, and the repeaters must be made so stable and reliable that continuity of service will be assured even when hundreds of repeaters are

(Continued on page 62)

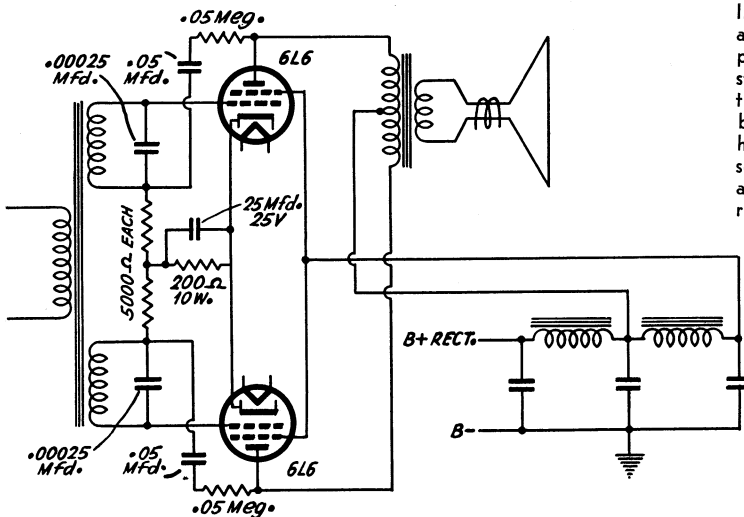

Inverse feedback applied to a pair of 6L6s in a push-pull circuit, with values stated. A ground connection is omitted and should be included, at the left-hand side of the 200-ohm self-biasing resistor. This is at the joint of the two upright 5,000-ohm resistors nearby.

The Radio Leader

for 1938

AMAZING KNIGHT 11 TUBE ALL-WAVE SUPERHET

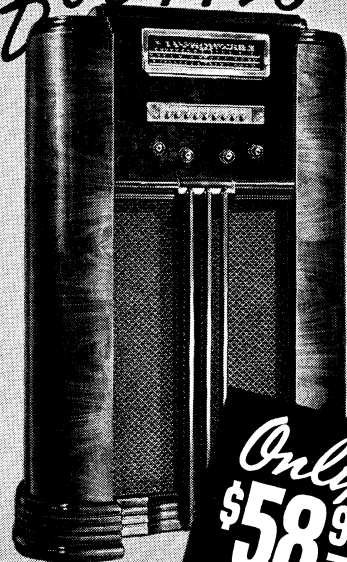

Only
\$58⁹⁵

New Kits

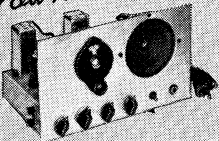

32 Build-Your-Own Kits—from a 1 Tube Set to a 14 Tube All-Wave Superhet! See these kits in the Radio Builders' section of the new ALLIED Catalog. Write for Free Parts Lists for building any set described in this magazine.

- AUTOMATIC ELECTRIC TUNING
- SELECT-O-MATIC DIAL
- ALL-WAVE RANGE
- AUTOMATIC FREQUENCY CONTROL
- 12" DYNAMIC SPEAKER
- PRE-SELECTOR STAGE

A POWERFUL PERFORMER — AT AN EXCEPTIONALLY LOW PRICE

1938's supreme Radio Value—with every desirable new feature! Electric Push-Button Tuning—press a button and there's your station instantly. Select-O-Matic 9" Horizontal Dial with all ranges in full view. Giant 12" Electro-Dynamic Speaker for perfect tonal quality. Tuning range covers everything on the air in three full bands from 16 to 550 meters. Powerful new R.C.A. and Hazeltine licensed Superhet circuit incorporates: Full 7 Watts Output; Double-Tuned I.F.'s; R.F. Preselector; 3-Gang Condenser; A.V.C.; Tone Control, etc. No other radio has all these features at so low a price. Here's the set that will bring you tremendous sales volume and big profits.

See this new radio and 64 other new 1938 KNIGHT models in the new 1938 ALLIED Catalog. Models from 5 to 16 tubes for AC, AC-DC, 6 Volt, 32 Volt, Battery, and Auto operation. These new KNIGHT models are Radio's Outstanding Values! Send coupon for Catalog.

ALLIED BRINGS YOU EVERYTHING IN RADIO IN THIS GREAT NEW CATALOG

ALLIED's 1938 Catalog is the COMPLETE Supply Guide for Everyone in Radio. P. A. Systems—new KNIGHT "Integrated" Sound Systems from 8 to 60 watts. Amateur Gear—new receivers, transmitters, transceivers—both factory-built and in kit form; all leading lines. Kits—Parts—Test Instruments—Books—Tools—etc. at Radio's lowest prices. Whether you're a Radio Dealer, Serviceman, P.A. Specialist, or Amateur-Experimenter, you need this great book. ALLIED's COMPLETE stocks and fast service save you time. ALLIED's low prices save you money. Quality equipment that cannot be surpassed—every item is tested and approved by our engineers. Write today for this new catalog. Send coupon now!

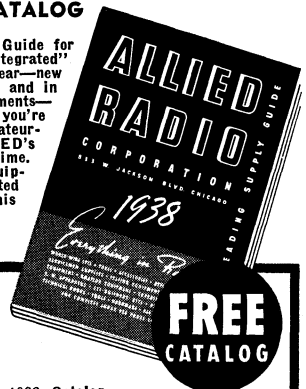

FREE CATALOG

12,000 Parts

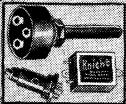

The 1938 ALLIED Catalog offers a tremendous selection of highest quality radio parts for building or repairing any circuit. All standard lines—at lowest prices—available for prompt shipment from our huge, clean stocks.

New Test Equipment



88 Newest Test Instruments—Radio's most extensive line. Oscilloscopes, Analyzers, Tube-Checkers, Set-Testers, Meters, etc. Latest factory-built and Build-Your-Own types. ALLIED offers instruments for every radio servicing or engineering need.

WRITE FOR FREE CATALOG TODAY

ALLIED RADIO CORPORATION

EVERYTHING IN RADIO AT LOWEST PRICES

ALLIED RADIO
Dept. 16-13
833 W. Jackson
Blvd.
Chicago, Ill.

- Send your Free 1938 Catalog.
- Send Free Parts List for.....

Name

Address

City State

.. (Continued from page 60)
 structure could be used to transmit this wide frequency band, the line structure employed—which gives its name to the system—consists of a copper conductor supported within a flexible copper tube by thin discs of hard rubber placed in series. Although other forms of line spaced a few centimeters apart along the entire length of the structure. Two of such coaxial units, one for each direction of transmission, are enclosed with two quads of nineteen-gauge paper-insulated wires in a lead sheath only seven-eighths of an inch in outside diameter. The experimental coaxial installation runs some ninety-five miles from the Long Lines Building, New York City, to the Bourse Building in Philadelphia. The entire run is underground, and repeaters are provided about every ten miles.

* * *

COMPRESSION AND EXPANSION

WHAT is the compandor and how is it applied to response levelling?—E. J. B.

If amplifiers of a radio transmitter are manually adjusted to keep the average volume constant, that is, to smooth out the differences caused by low or loud talking, there will still remain an amplitude range of nearly forty db, representing the difference between the strong vowel and the weak consonant sounds. The compandor provided a compressor at the transmitting end that introduces a gain varying inversely with a function of the signal amplitude from twenty db for the weak signals to zero db for the strong signals. With the compressor in the circuit, therefore, the amplitude of the output signals of the transmitter varied only over a twenty db range instead of over the forty db range. The expandor at the receiving end performed the inverse function; it introduced a loss varying inversely with a

function of the signal strength, and thus expanded the instantaneous voltage range from twenty db back to the original forty db.

* * *

POWER OUTPUT REQUIRED

FOR intercommunication systems in factories of 20,000 to 30,000 square feet floor space what would you recommend as the power output of the amplifier?—K. E.

The power output should be seven watts.

Still Bigger Ad Campaign by Cornell-Dubilier

With every sign pointing to a greatly increased radio market this Fall and Winter, the Cornell-Dubilier Electric Corporation, condenser manufacturers, of South Plainfield, N. J., will increase their advertising appropriation by 25 per cent, effective immediately, according to an announcement by Leon L. Adelman, advertising manager.

Plans call for larger units of space in radio, electrical and utility trade papers with most of the insertions utilizing color. Dealer and jobber point-of-sale helps and window displays will also figure prominently. The account is handled by Reiss Advertising, Inc., Rockefeller Center, N. Y.

CABINET PATCHER ANNOUNCED

General Cement Mfg. Co., Rockford, Ill., announces a patch kit for filling in deep nicks and scratches in radio, refrigerator and other cabinets. Woods as well as plastic and bakelite cabinets may be noticeably patched.

RADIO GIMBAL

A New Chassis Cradle for Speed and Profit in SERVICING

FOR testing and repairing receivers or amplifiers, every radio service shop needs the RADIO GIMBAL. It can be adjusted to any desired angle and permits top, underside and left- or right-side examination, as well as inspection of any intermediate arrangements. Conveniently accommodates any chassis up to 13" x 12" by 21".

Senior Radio Gimbal net.....\$6.00

Junior model chassis cradle net.....\$3.50

Senior Model (illustrated) has two frames. Junior Model has one frame.

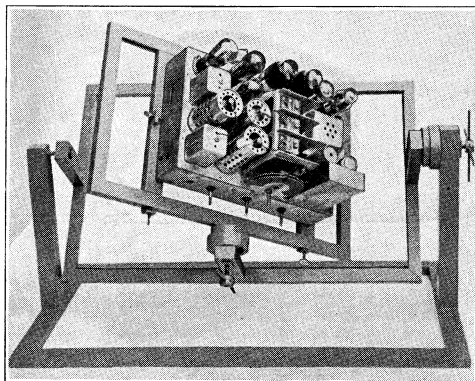

Write for illustrated circular RW.

THE W. A. THOMAS COMPANY, 321 Caroline St., Neenah, Wisc.

● FREE COPY of Shiepe's "Inductance Authority" with any instrument order ●

NEW 1938 DELTA SIGNAL GENERATOR



Partly exposed tubes cushioned against shock give this portable instrument great frequency stability because of good ventilation, rendering the instrument far more compact and handy than any other on the market, regardless of price.

90 kc to 30,000 kc on fundamentals only, using 6 bands by switching. The switch automatically shorts out all unused coils. The indicator is a transparent Bakelite pointer which does not bend or break. Leather handle on top of shielded steel cabinet.

Beautiful black metal-etched panel with white lines, minimizing glare. Separate 400 cycle audio oscillator for modulation frequency, controlled by toggle-switch. Provision for external wobbler for use with cathode-ray-oscillograph.

Overall size 8½" x 6" x 3½" deep.

Operates from 105-125 volts AC or DC. 220 volts model also available. Price, complete with tubes, ready to operate **\$15.95**

Shipping weight, 5 lbs.

WRITE FOR CIRCULAR

HERE'S YOUR CHANCE FOR A REAL BARGAIN IN A 3-INCH CATHODE-RAY-OSCILLOGRAPH

either in KIT form or Complete-Ready-to-Operate

Delta's recent purchase of the Paragon Radio Products Co. has made it possible to make available this remarkable oscilloscope at a great saving. This offer holds only while the limited stock is still on hand. Better get yours now and save, while you still have the chance.

We will be glad to hold one of these instruments for you for a reasonable time if you will put a small deposit on it. Write for descriptive circular and act quickly, for here's the chance to get that 'scope you've always wanted. Available also in kit form. Price, complete with tubes **\$44.75**

Assembled Parts Kit.....\$24.60

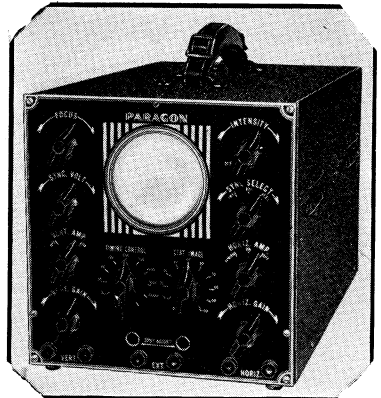

Kit of Tubes.....\$15.50

COILS TO ORDER INDUCTANCE STANDARDS

We are equipped to wind inductance coils to your specification. Honeycomb windings for IF transformers, high-gain primaries for broadcast coils or other bands, tapped or un-tapped oscillator coils to any inductance between 1 microhenry and 50 millihenries.

Single coils mounted on bakelite with lugs and

mounting bracket, from 1 microhenry to 1 millihenry, \$2.00 each for one coil, \$3.00 for 2 similar coils, and lower quantity prices. From 1 M.H. to 10 M.H., \$2.50 per coil, \$3.50 for two, etc. 10-50 M.H., \$3.00 per coil, \$4.00 for two, etc. Accuracy better than 1 percent when required for pure inductance. These coils make excellent inductance standards.

DELTA RADIO COMPANY

Phone
REctor 2-6650

135 Liberty St., New York, N. Y.

CLASSIFIED ADVERTISEMENTS

7 cents a word. \$1.00 minimum.

AMATEUR RADIO, Commercial Radiotelephone and Radio-telegraph licenses, complete training. Resident and correspondence courses. Every graduate a licensed operator. NEW YORK WIRELESS SCHOOL, 1123 Broadway, New York.

MAKE YOUR OWN PRODUCTS. Employ agents yourself. Toilet articles, soap, extracts. We furnish everything. Valuable book free. National Scientific Laboratories, 1950 R.W. Broad, Richard, Va.

INSTRUCTIONS. DISTANCE RECORD CRYSTAL SET. 17 others, with "Radiobuilder" year—25c. Laboratories, 151 R.W. Liberty, San Francisco.

WANTED ORIGINAL POEMS, SONGS, for immediate consideration. Send poems to Columbian Music Publishers Ltd., Dept. 95, Toronto, Can.

HAVE YOU BACK NUMBERS of Radio World, for May, August, 1937, or April, June, September, October, 1936? If so, please communicate with Radio World, 145 West 45th St., New York, N. Y.

RADIO EXPERIMENTERS AND SET BUILDERS; parts and kits of parts for improved Little Giant R235, six tube R233. Pre-amplifier R228, Portable battery R223, Little Giant R220 and 205 and 6 volt R238. Guaranteed specified parts. Lund Manufacturing Co., Dept. R.W., 43 East Ohio, Chicago.

FOOL YOUR FRIENDS. Quarter brings six Niagara Falls views. You write message—Stamp—Address—Return. Mailed at Niagara Falls. Mack's Service, 213 Madison, Buffalo, N. Y.

FREE! PROFUSELY ILLUSTRATED BOOKLET. "Scientific Wonders." Contains drawings, photographs and diagrams showing marvels of movies, power, television, nature, ingenious inventions, etc. Also many fascinating articles on mechanics, astronomy, biology, chemistry, engineering, etc. Metro, Dept. R.W., 70 Fifth Ave., New York.

CHRISTMAS CARDS—50 BEAUTIFUL FOLDERS, name imprinted, cost 65c, sell for \$1.00. Marvelous 21-folder assortments sell for 60c and \$1. pay you 100% profit. Be first with this great new 1937 line! Extra bonuses for early sales. Samples free. Start now! New England Art Publishers, Dept. R.W., North Abington, Mass.

"INFORMATION IS BEING SOUGHT of the whereabouts of LOUIS HOLLANDER alias "DUTCH," a radio repair man, who disappeared from the Bronx, N. Y., in June, 1933, and since then has failed to make provision for his wife, Helen, and their infant son, Owen, so that the family is dependent on the Emergency Relief Bureau. This man was born in New York in 1905, 5 ft., 9 in. tall, weighs 150 pounds, has light brown hair, grey eyes. Anyone knowing of his location is requested to communicate with the National Deserption Bureau, 67 West 47th Street, New York City."

INDUCTANCE BOOK

Free! Every solenoid for every radio-frequency or intermediate frequency may be wound of standard wire on standard form diameters without any computations by using "The Inductance Authority," by Edward M. Shiepe. This \$2 book sent free, postpaid, with supplement, on receipt of \$5 for a 2-year subscription for RADIO WORLD.

RADIO WORLD, 145 W. 45th St., N. Y. C.

A COMBINATION OFFER! RADIO WORLD and "RADIO NEWS" \$3.50

Canadian and Foreign, \$1.50 extra on this offer.

You can obtain the two leading radio technical magazines that cater to experimenters, service men and students, for one year each, at a saving of \$1.50. The regular mail subscription rate for RADIO WORLD for one year is \$2.50. Send in \$1.00 extra, get "Radio News" also for a year—a new issue each month for twelve months. Total 24 issues for \$3.50 and \$5.00 to foreign countries.

RADIO WORLD 145 West 45th Street, N. Y. City

TELEVISION

"TELEVISION WITH CATHODE RAYS," by Arthur H. Halloran. Farnsworth and Zworykin systems fully explained. The treatment is mathematical. It is a book for the well-grounded radio man who has vision, the man who wants to be among the first to cash in when the pictures go on the air commercially, but is not for novices. 100 pages or more of supplementary data. Price \$2.75 postpaid including Supplements).

RADIO WORLD

145 West 45th Street, New York City, N. Y.

When writing to Advertisers please mention that you saw the Advertisement in RADIO WORLD.

SPECIAL 2-FOR-1 OFFER RADIO WORLD

Radio World is \$2.50 a year (12 issues), 25c. per copy. Canada and foreign, \$3.00 yearly. Offers of Radio World and other worthwhile publications for one full year on each (NET):

- RADIO WORLD and SHORT-WAVE and TELEVISION, \$3.50.
- RADIO WORLD and POPULAR SCIENCE MONTHLY, \$3.50.
- RADIO WORLD and RADIO-CRAFT (12 issues), \$3.50.
- RADIO WORLD and RADIO INDEX (monthly, 10 issues), stations, programs, etc., \$3.50.
- RADIO WORLD and SERVICE (monthly), \$3.50.
- RADIO WORLD and EVERYDAY SCIENCE and MECHANICS (monthly), \$3.50.
- RADIO WORLD and BOYS' LIFE (monthly, 12 issues), \$3.50.
- RADIO WORLD and TRUE STORY (monthly), \$3.00.
- RADIO WORLD and LIBERTY (weekly), \$3.00, U. S. only.

Select any one of these magazines and get for an entire year by sending in a year's subscription for RADIO WORLD at the regular price, \$2.50, plus a small additional amount, per quotations above. (Add \$1.50 for extra foreign or Canadian postage for both publications.)

Name

Address

City and State.....

- If renewing an existing or expiring subscription for RADIO WORLD, put cross in square.
- If renewing an existing or expiring subscription for other magazines, put cross in square.

Special Trial Offer for Radio World only: \$1.00 for 5 months, postpaid. Mail order with remittance to Radio World Office. NET.

RADIO WORLD, 145 W. 45th St., New York



Ghirardi's "TROUBLE SHOOTERS"

DO THE WORK—BUT YOU GET THE MONEY

SPEED UP YOUR SERVICE WORK by using Ghirardi's amazing new "TWIN" pocket-size radio "TROUBLE-SHOOTERS" that instantly tell you exactly where to find the defect in a circuit by the "Trouble Symptom" method. It's absolutely amazing the time they'll save you, the work they'll do for you. They'll point the way directly to over 800 DIFFERENT RECEIVER TROUBLES—and their REMEDIES—in a jiffy! **HOW THEY WORK:** Easy as pie to use them—you take up your Gadget, pick out the eyeletted card marked for the particular Trouble Symptom you find in the "sick" receiver; flip the card around, and there you'll see all the possible Causes for the particular trouble, the exact Tests to make, and the Remedies to apply. Work quick as a flash—almost like magic! Get you right to the trouble in a jiffy, without "fussing" around. One 9-card Gadget for HOME RADIOS—one with 12-cards for AUTO RADIOS. Each one "spots" over 400 different set troubles. All they cost is \$1 a pair (\$1.20 foreign). **FIN A DOLLAR TO THIS AD,**

write your name and address in the margin, and mail it NOW for both Gadgets! You don't risk a penny! Sent postpaid anywhere!



Radio & Technical Publishing Co.
Dept. RW-127,
45 Astor Pl., New York
Money-Back Guarantee

MAIL
\$1-
NOW!

You need **2** books

RADIO SERVICING SHORT-CUTS
and Money Making Ideas

A completely new and different book tells how radios may be repaired quickly with the absolute minimum of test equipment. Proves that by an actual test 9 out of 10 radios can be fixed with simple tools and volt-ohmmeter. The author, M. N. Beitman, for years in the servicing profession, realized and kept data on these facts. Page after page of practical information. Many real money-making ideas and hints applicable to all sets. (Size: 8½ x 11 in.)

PUBLIC ADDRESS SYSTEMS

A practical handbook, full of useful information, fully illustrated. Considers in detail various microphones, radio and phonograph inputs, acoustic feed-back, mixing and volume control, use of vacuum tubes, interstage coupling, power amplifiers, output coupling, loud speaker placement, the decibel, P.A. measurements, power level, and other points of importance, including actual circuit diagrams of tested P.A. systems.

Price, 50c each book.

SUPREME PUBLICATIONS

3727 West 13th St., Chicago, Illinois

RADIO COURSES

RADIO OPERATING: Prepare for Gov't License Exam. ● **RADIO SERVICING:** Including Short Wave ● **AMATEUR CODE** ● **ELECTRONICS** ● **TELEVISION** ● Day and Evening Classes—Booklet Upon Request
NEW YORK Y. M. C. A. SCHOOLS
3A W. 63rd Street, New York City

SENSATIONAL

is only a mild word with which to describe

FILMANIA

BY PAUL D. HOSIER

The most daring book of "behind the scenes" true stories and facts ever written about glamorous Hollywood and the Motion Pictures.

SPECIAL HALF-PRICE OFFER

For a very limited time, orders will be accepted for this astounding book at \$1.50 a copy—one-half the regular price—postage prepaid if cash is sent with your order. Send for your copy TODAY.

PAUL D. HOSIER

Author and Publisher

5826 Hollywood Blvd., Hollywood, Cal.



LOWEST PRICES

GUARANTEED QUALITY

FASTEST SERVICE

The New 1938 Radolek Radio Profit Guide contains complete showings of Radio Repair Parts, Radio Receivers, Public Address Amplifiers, Speakers, Microphones, Test Instruments, Technical Books, Special Tools. Leading Standard Brands! Everything you need in the Radio Business all at Lowest Prices. You save money at Radolek!

Every item you get from Radolek is guaranteed. It must be right or we make it right. Standard merchandise produced by leading Manufacturers with Radolek's guarantee added!

Everything in Radio promptly when you want it—and exactly what you want. Radolek's efficient organization backed by a huge stock of guaranteed merchandise insures you fastest service. 25,000 Servicemen benefit by Radolek's **LOWEST PRICES**. Send Now for the Radolek Radio Profit Guide. It will help you make money.

RADOLEK

601 W. RANDOLPH, CHICAGO, Dept. G-12

Send me the 1938 Radolek Radio Profit Guide FREE.

Name

Address

Serviceman? Dealer? Experimenter?

CHASSIS—CABINETS PANELS & CANS

STANDARD SIZES ON HAND
SPECIAL SIZES MADE TO ORDER

KORROL RADIO PRODUCTS CO.

232 Greenwich St. R.W. 11-37 New York City



STUDY RADIO

PAY AFTER GRADUATION
Entirely new, different Radio Servicing Course prepared with the help of 40 leading radio manufacturers. Planned to fit you immediately into a good pay radio job. We are so sure you will make real money after graduation that (except for one small down payment) we will let you pay later, out of your radio earnings. Write today for this "Earn Your Way" plan. It's Free.

3729 West 18th St.
Chicago, Ill.

RADIO TECHNICAL INSTITUTE

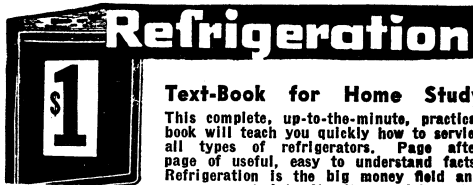

Text-Book for Home Study

This complete, up-to-the-minute, practical book will teach you quickly how to service all types of refrigerators. Page after page of useful, easy to understand facts. Refrigeration is the big money field and you can get into it after studying this

textbook. Size 8 1/2 x 11 in. Priced at only \$1.00, postpaid. Send for your copy now.

SUPREME PUBLICATIONS

3729 WEST 18th STREET

CHICAGO, ILL.

MILLION TUBE TESTER



FEATURES:

1. Emission
2. Metal Tubes
3. Shorts Hot
4. Leakage Hot
5. Resistance
6. Electrolytic
7. By-pass Condensers
8. D'Arsonval Meter

MODEL CP

\$13.95 NET

MODEL TM, with large 3" square D'Arsonval Meter and Continuous Line Voltage Adjustment, **\$16.95** Net

Your Jobber's Name and 20% Deposit Required on All Direct Orders.

Send for Free Literature!

MILLION Radio and Television Laboratories

595 N. Union Street, Chicago, Ill.

THE HAYNES POCKET RECEIVER

Has Created A Tremendous Sensation

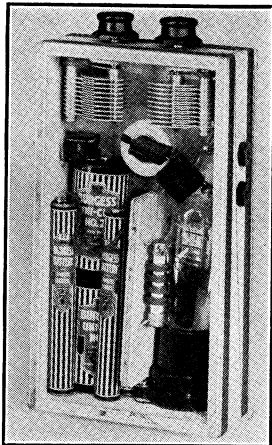

A true pocket receiver which really works like a charm giving practical reception of the local broadcast stations while concealed in your pocket.

In line with our policy of featuring all of the new radio developments which are worth while Douglas Radio is offering exact duplicates of Mr. Haynes' original model (which has been on demonstration at our store) either in kit form or completely wired and tested.

Price of complete Pocket Receiver with tube, ready to operate. Less only ear phones) **8.95**

Price of complete kit including batteries, tube, wire, knock-down plywood case, etc. **5.95**

Special Interruptor Coil Only **69c**

14 Ohm Resistor **10c**

Burgess Z2 Batteries Each **10c**

Burgess No. 2 Batteries..... **10c**

We make a specialty of catering to the radio experimenter and keep on demonstration many novelties and exclusive developments such as capacity relays, infrared light beam alarms, volume expanders, etc. We can also save you money on power amplifying equipment or supply practically any size chassis and panel from stock. Ask us for a FREE circuit diagram if you want to build a receiver or amplifier.

DOUGLAS RADIO CO.

89 Cortlandt Street

New York, N. Y.

For
TROUBLE-FREE
 Dependable Service

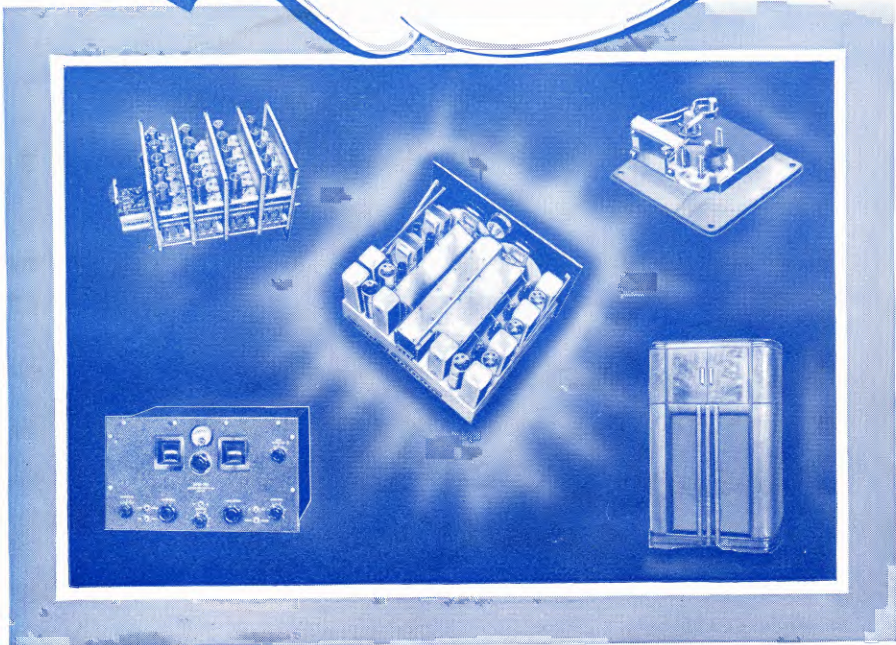

THE NEW "SUPER-PRO"

THE new "Super-Pro" with its distinctive design and rugged construction, provides "trouble-free, dependable service" so essential to the critical amateur and professional for his important and exacting air activities. Among the "Super-Pro" features that contribute to this superior efficiency is the husky, self-contained tuning unit, with its unique noiseless band-change cam knife switch. Silver plated knives and contacts insure low resistance contact for each circuit. No moving part carries current to cause noise or provide stray coupling. In addition, the tuning unit has 20 separate coil assemblies, with coils wound on highest grade bakelite and mounted on Isolantite bases. All coils have copper disc inductance adjusters and variable trimming capacitors permitting precision alignment at low and high frequency ends of the bands. The tuning unit also has a shielded 4-gang tuning condenser and 12-gang band spread condenser with soldered brass Midline plates, stainless steel rotor shaft, and steel ball bearings affording smooth and accurate tuning.

Other features of the "Super Pro" are - two RF stages on all bands, calibrated band width (3 to 16 kc) beat oscillator, audio and sensitivity controls,

direct tuning, high fidelity, variable crystal filter, C W - Mod Standby A V C Man Speaker Phone switches, relay strip 8 metal and 8 glass tubes. Crystal or standard types available in table model rack panel, or console for 7½ to 240 or 15 to 560 meters. Console model has a bass reflex sealed sound chamber and a 15" high fidelity speaker.

See and hear this outstanding receiver today. If you haven't the name of your local authorized Hammarlund dealer mail coupon below for these data and complete details on the new Super Pro.

HAMMARLUND MFG. CO., INC.
 424-438 W. 33d St., N. Y. City

- Please send me "Super-Pro" bulletin.
 Please send me "Super-Pro" Console bulletin.
 Please send me dealer listing

Name _____

Address _____

City _____

State .. _____

RW-11



HAMMARLUND

Square Cases By...



Sensitive and Ultra Sensitive Indicating Instruments. . . D.C., Moving Coil . . . A.C., the Repulsion Type.

Specify Triplet for the finest, most up-to-date instruments in appearance, performance and economy.



Model 426



Model 421

**EVERY
STYLE
FOR
EVERY
NEED**



Model 326-A



Model 326

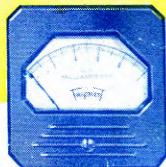

Model 327



Model 227

Available with Front or Rear Illumination

TRIPLETT INSTRUMENTS ARE NOTED FOR— Highest Quality

1. Bar Bridge Construction.
2. Magnet Pole Pieces Are Continuous — Gauged to Precision Accuracy.
3. Fewer Magnetic Parts—Greater Initial and Lasting Accuracy.
4. Fully Aged to Relieve Strains and Unnecessary Adjustments.

5. Unsurpassed for Ruggedness and Wearing Qualities.

Low Cost

1. Recognized in Industry for Greatest Value in Instruments.
2. Produced on Quantity Production Basis.
3. Manufactured by Highly Skilled Workers.

● Other standard types available include Round Cases—2", 3" and 5" sizes; Fan Type Cases—4" x 4⁷/₈" overall case size; Twin Case (2 instruments in one case) 3⁵/₈" x 5¹/₂"; Portables—3" and 5" sizes.

If you have an electrical instrument problem, write to TRIPLETT.

THE TRIPLETT ELECTRICAL INSTRUMENT COMPANY,
2711 Harmon Avenue, Bluffton, Ohio

Please send me more information on Triplet Models
..... I am
also interested in.....

Name

Address

City..... State.....



ELECTRICAL INSTRUMENTS